

ES4600-K0-T1 Exit Alarm Configuration

Specifications: ES4600

- Power: **12-24 VAC/VDC at 500mA**
- Output Relays: **N/C & N/O contact 1000mA at 30 VDC**
- Remote Speaker: **3 Watts 8 Ohms**
- Warning message: **"Please close the door"**
- Alarm message: **"Security violation, close the door"**

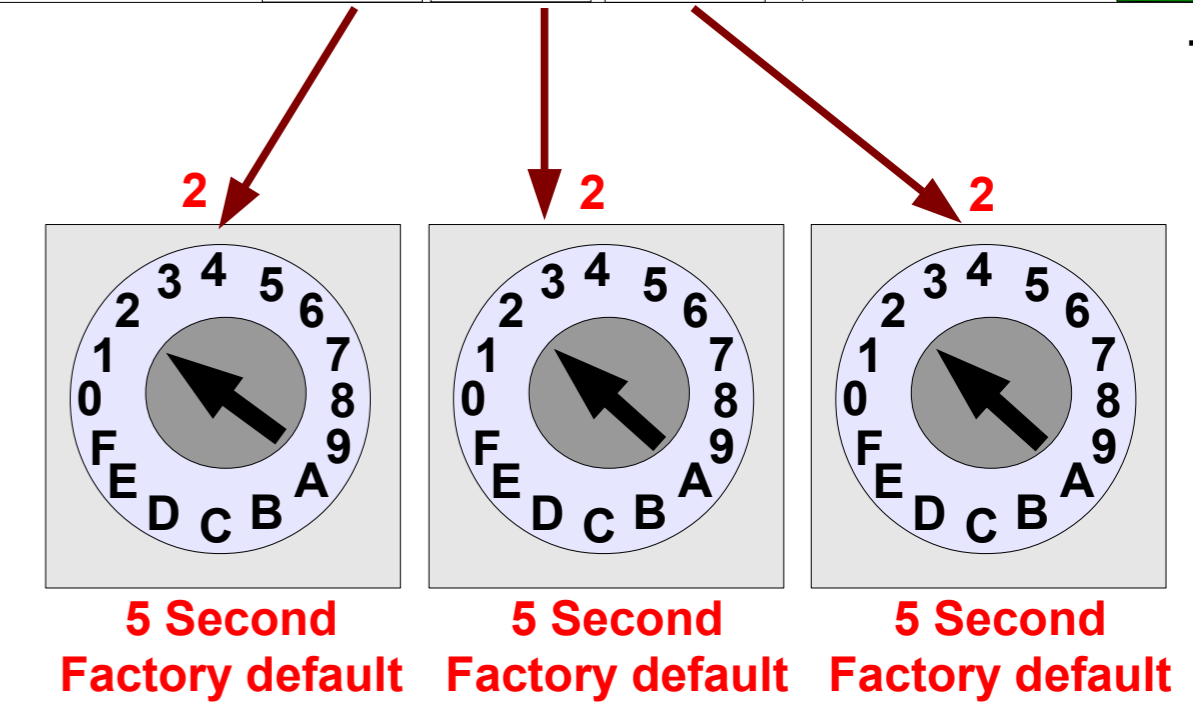
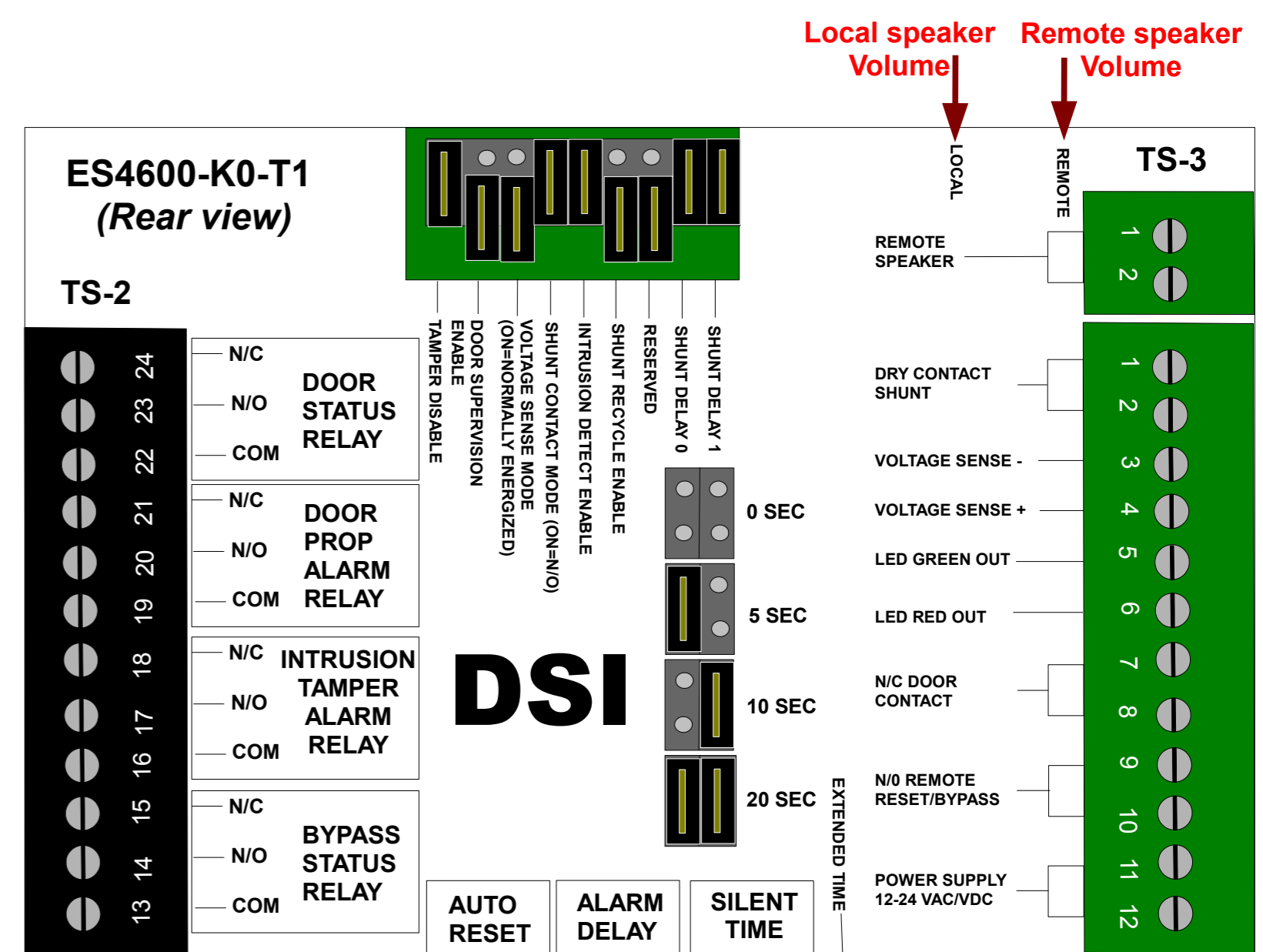
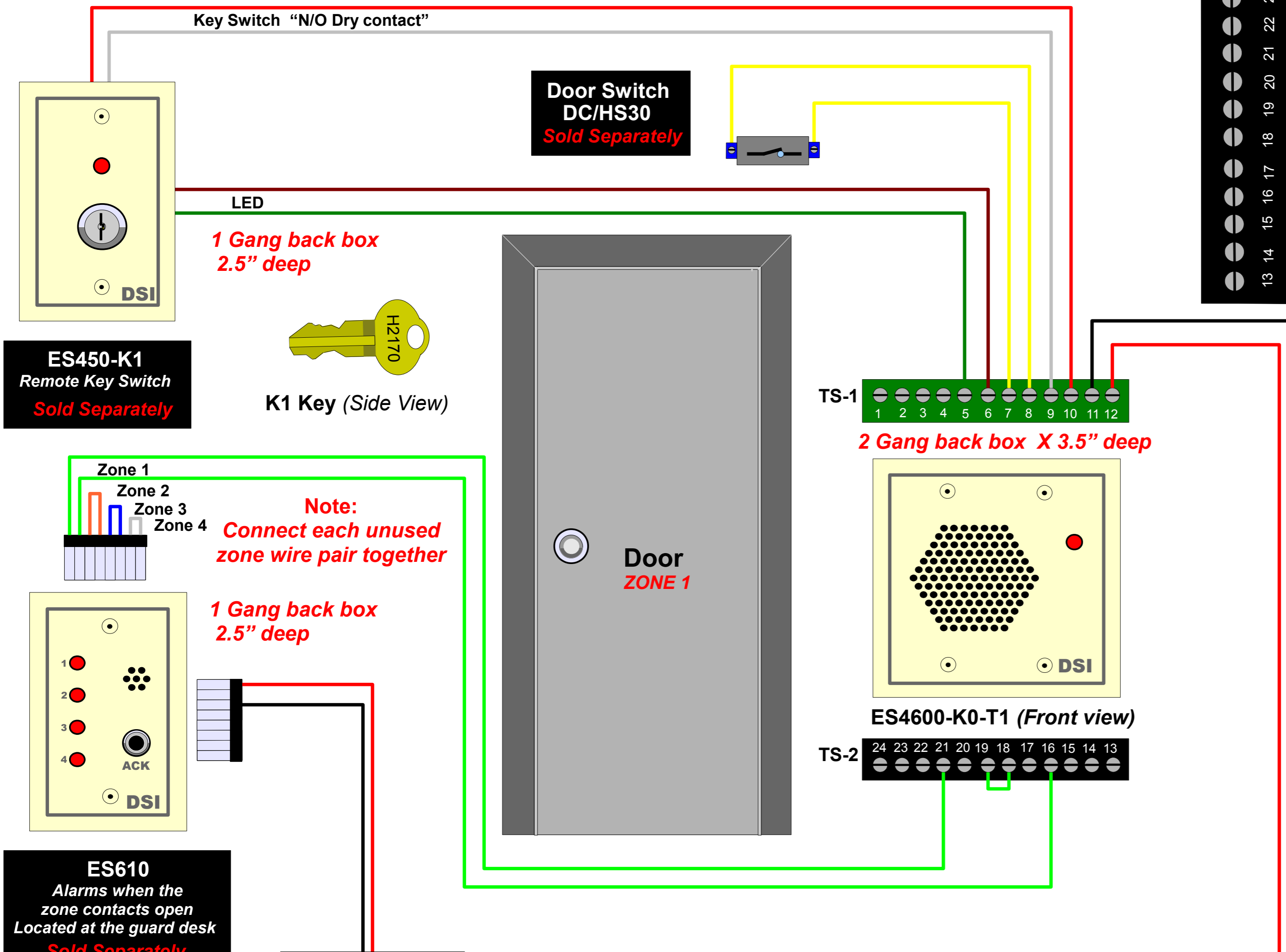

SET	Auto Reset	Alarm Delay	Silent Time	
			Normal	Extended
0	0 Sec	0 Sec	0 Sec	3 Min
1	3 Sec	3 Sec	3 Sec	3.5 Min
2	5 Sec	5 Sec	5 Sec	4 Min
3	7 Sec	7 Sec	7 Sec	4.5 Min
4	10 Sec	10 Sec	10 Sec	5 Min
5	12 Sec	12 Sec	12 Sec	6 Min
6	15 Sec	15 Sec	15 Sec	7 Min
7	20 Sec	20 Sec	20 Sec	8 Min
8	30 Sec	30 Sec	25 Sec	9 Min
9	45 Sec	45 Sec	30 Sec	10 Min
A	1 Min	1 Min	35 Sec	20 Min
B	2 Min	2 Min	45 Sec	30 Min
C	3 Min	3 Min	1 Min	40 Min
D	4 Min	4 Min	1.5 Min	50 Min
E	5 Min	5 Min	2 Min	60 Min
F	Manual	Infinite	2.5 Min	90 Min

Note: Wire Gauge:
22 AWG = Signal wires
22 AWG = Power wires
(Power runs over 50 feet use 18 AWG)

Note: Suggested Power Supply
PS/DC12
PS/AC16

12-24 VAC/VDC 500mA Power Supply Sold Separately

ES4600-K0-T1 Exit Alarm Configuration

Supervised Door

Specifications: ES4600

Power: 12-24 VAC/VDC at 500mA

Output Relays: N/C & N/O contact 1000mA at 30 VDC

Remote Speaker: 3 Watts 8 Ohms

Warning message: "Please close the door"

Alarm message: "Security violation, close the door"

Supervision Enable
Jumper placement

Use 1K OHM resistors
on door switch

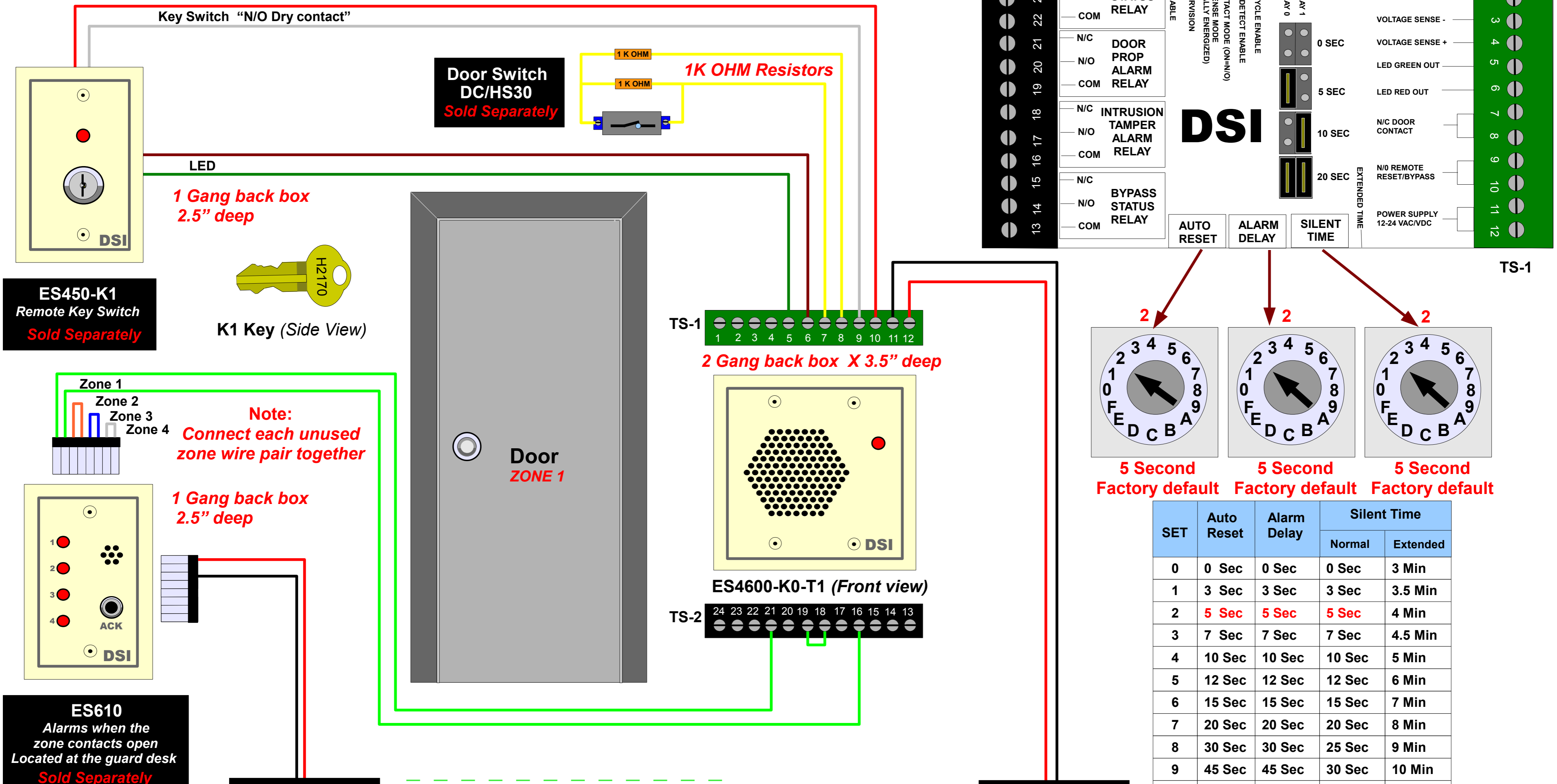

1 Gang back box
2.5" deep

Note:
Connect each unused
zone wire pair together

1 Gang back box
2.5" deep

2 Gang back box X 3.5" deep

Note:
Wire Gauge:
22 AWG = Signal wires
22 AWG = Power wires
(Power runs over 50 feet use 18 AWG)

Note:
Suggested Power Supply
PS/DC12
PS/AC16

12-24 VAC/VDC
500mA
Power Supply
Sold Separately

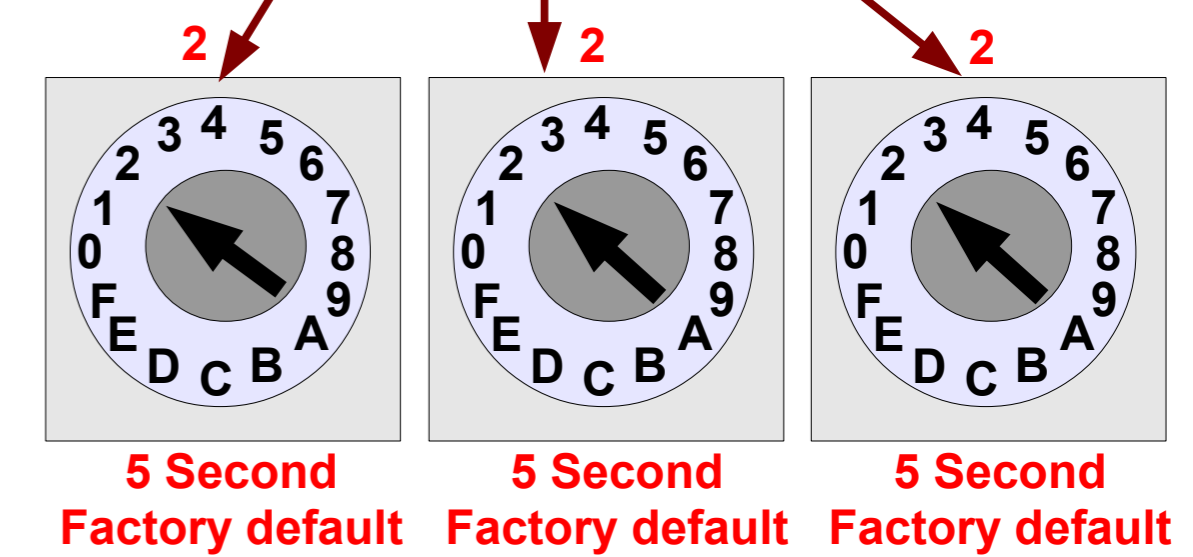

SET	Auto Reset	Alarm Delay	Silent Time	
			Normal	Extended
0	0 Sec	0 Sec	0 Sec	3 Min
1	3 Sec	3 Sec	3 Sec	3.5 Min
2	5 Sec	5 Sec	5 Sec	4 Min
3	7 Sec	7 Sec	7 Sec	4.5 Min
4	10 Sec	10 Sec	10 Sec	5 Min
5	12 Sec	12 Sec	12 Sec	6 Min
6	15 Sec	15 Sec	15 Sec	7 Min
7	20 Sec	20 Sec	20 Sec	8 Min
8	30 Sec	30 Sec	25 Sec	9 Min
9	45 Sec	45 Sec	30 Sec	10 Min
A	1 Min	1 Min	35 Sec	20 Min
B	2 Min	2 Min	45 Sec	30 Min
C	3 Min	3 Min	1 Min	40 Min
D	4 Min	4 Min	1.5 Min	50 Min
E	5 Min	5 Min	2 Min	60 Min
F	Manual	Infinite	2.5 Min	90 Min

ES4600-K0-T1 Door Prop Configuration

Specifications: ES4600

- Power: **12-24 VAC/VDC at 500mA**
- Output Relays: **N/C & N/O contact 1000mA at 30 VDC**
- Remote Speaker: **3 Watts 8 Ohms**
- Warning message: **"Please close the door"**
- Alarm message: **"Security violation, close the door"**

Intrusion Detect Enable Jumper placement

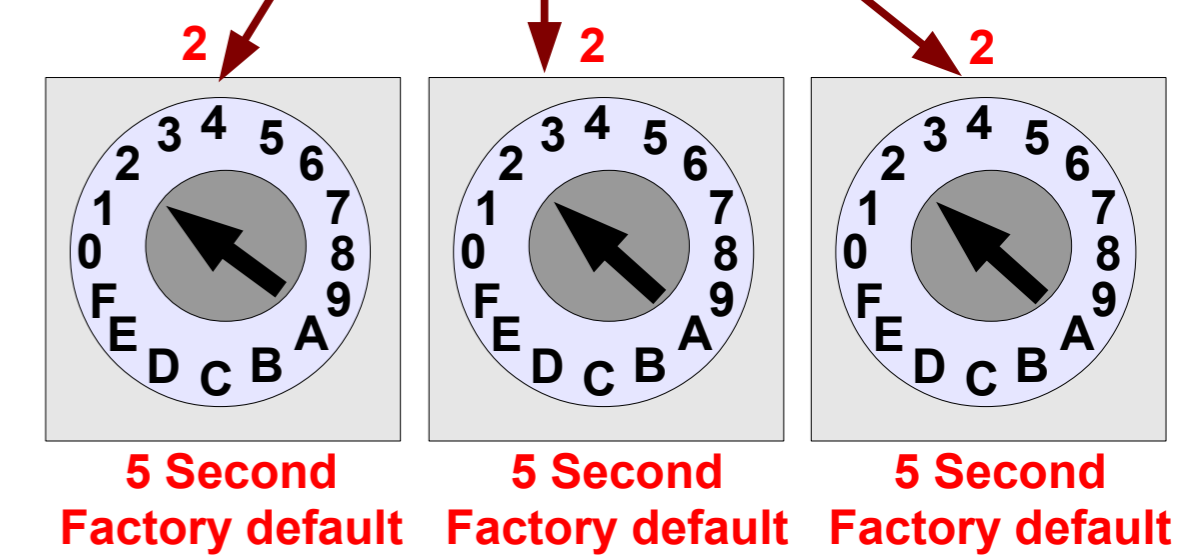
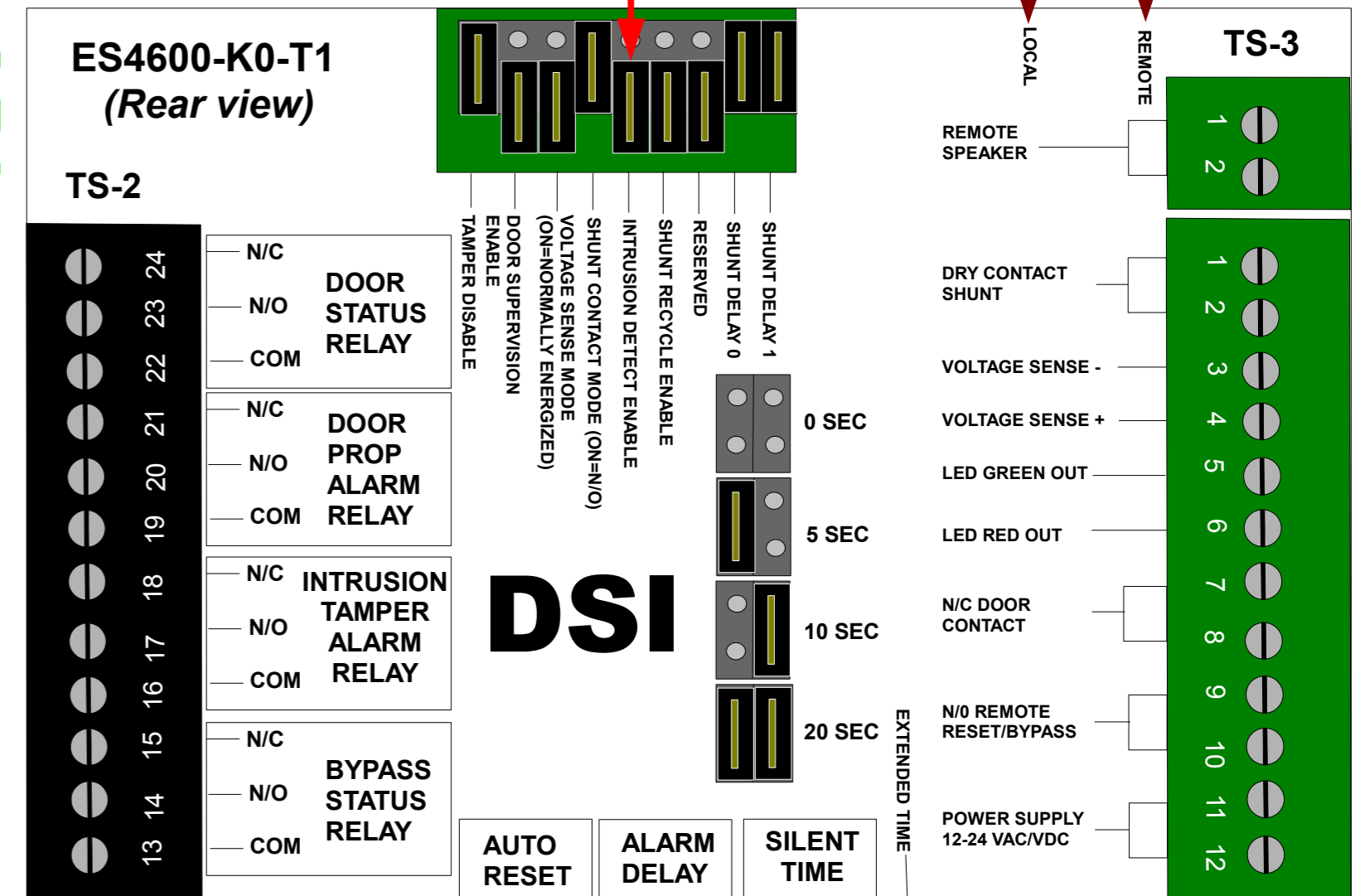
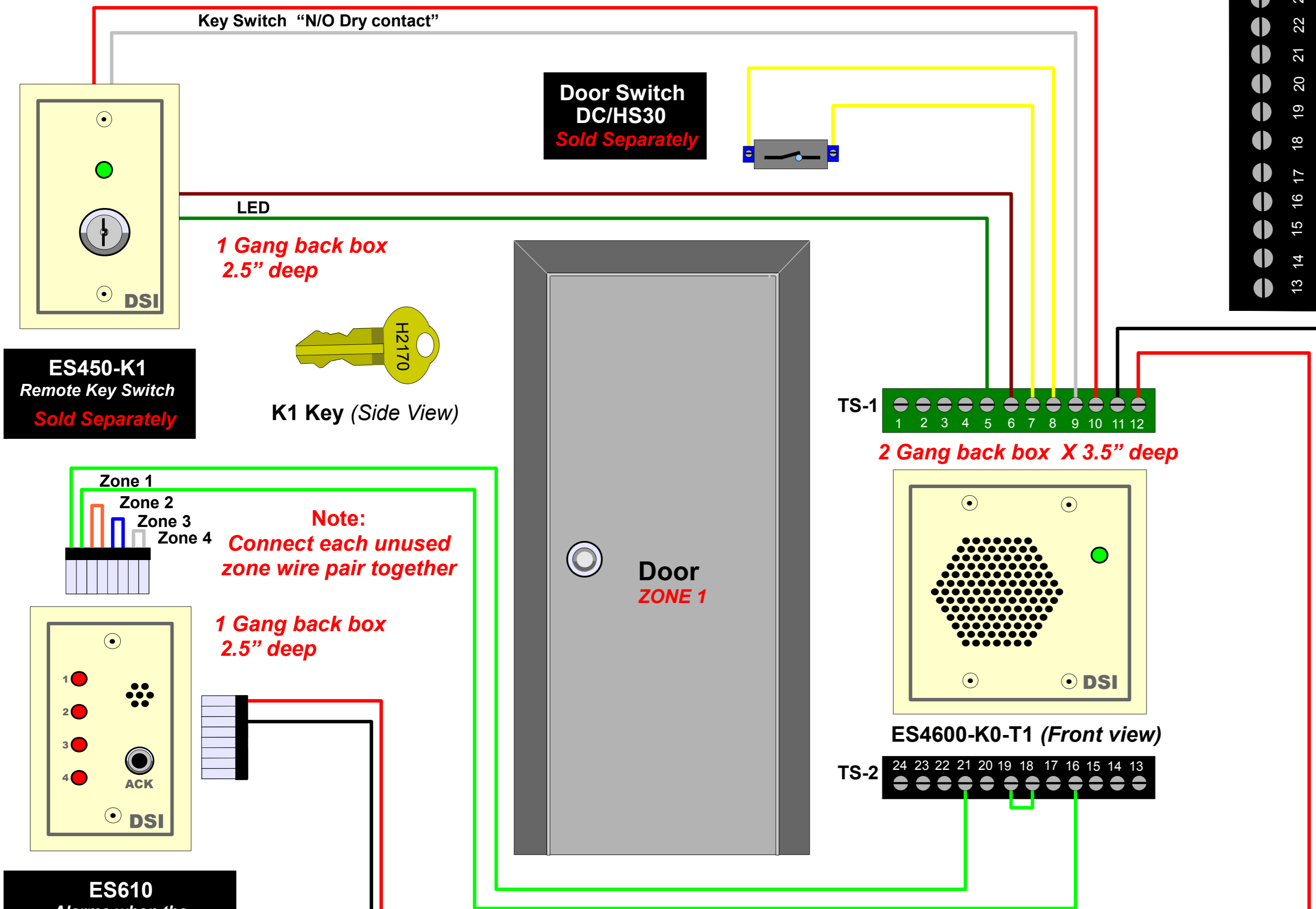

SET	Auto Reset	Alarm Delay	Silent Time	
			Normal	Extended
0	0 Sec	0 Sec	0 Sec	3 Min
1	3 Sec	3 Sec	3 Sec	3.5 Min
2	5 Sec	5 Sec	5 Sec	4 Min
3	7 Sec	7 Sec	7 Sec	4.5 Min
4	10 Sec	10 Sec	10 Sec	5 Min
5	12 Sec	12 Sec	12 Sec	6 Min
6	15 Sec	15 Sec	15 Sec	7 Min
7	20 Sec	20 Sec	20 Sec	8 Min
8	30 Sec	30 Sec	25 Sec	9 Min
9	45 Sec	45 Sec	30 Sec	10 Min
A	1 Min	1 Min	35 Sec	20 Min
B	2 Min	2 Min	45 Sec	30 Min
C	3 Min	3 Min	1 Min	40 Min
D	4 Min	4 Min	1.5 Min	50 Min
E	5 Min	5 Min	2 Min	60 Min
F	Manual	Infinite	2.5 Min	90 Min

Note: Wire Gauge:
 22 AWG = Signal wires
 22 AWG = Power wires
 (Power runs over 50 feet use 18 AWG)

Note: Suggested Power Supply
 PS/DC12
 PS/AC16

ES610
 Alarms when the zone contacts open
 Located at the guard desk
 Sold Separately

ES450-K1
 Remote Key Switch
 Sold Separately

12 VDC 150mA Power Supply
 Sold Separately

12-24 VAC/VDC 500mA Power Supply
 Sold Separately

ES4600-K0-T1 Magnetic Lock Configuration

Push Button REX

Specifications: ES4600

Power: 12-24 VAC/VDC at 500mA

Output Relays: N/C & N/O contact 1000mA at 30 VDC

Remote Speaker: 3 Watts 8 Ohms

Warning message: "Please close the door"

Alarm message: "Security violation, close the door"

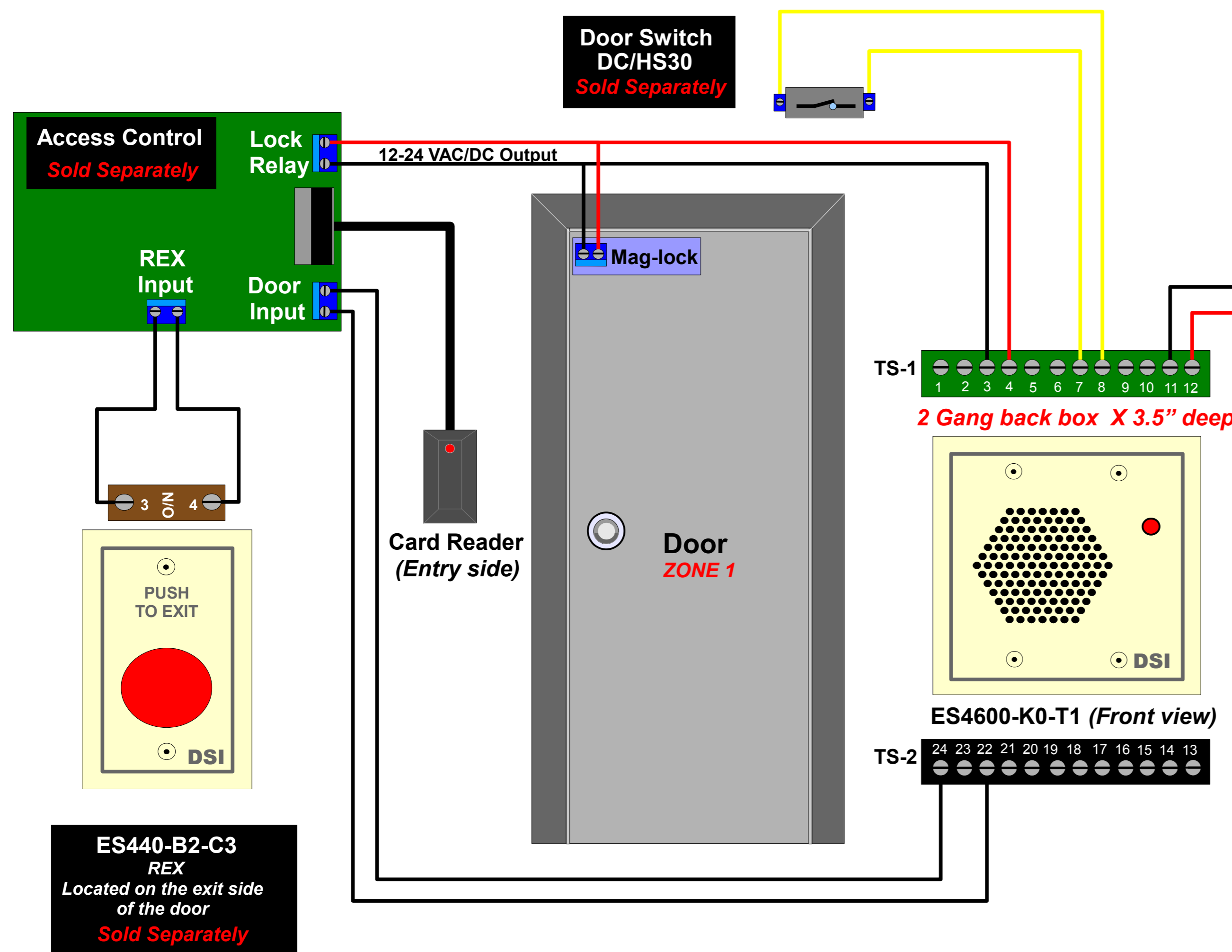

Voltage Sense Mode Jumper placement

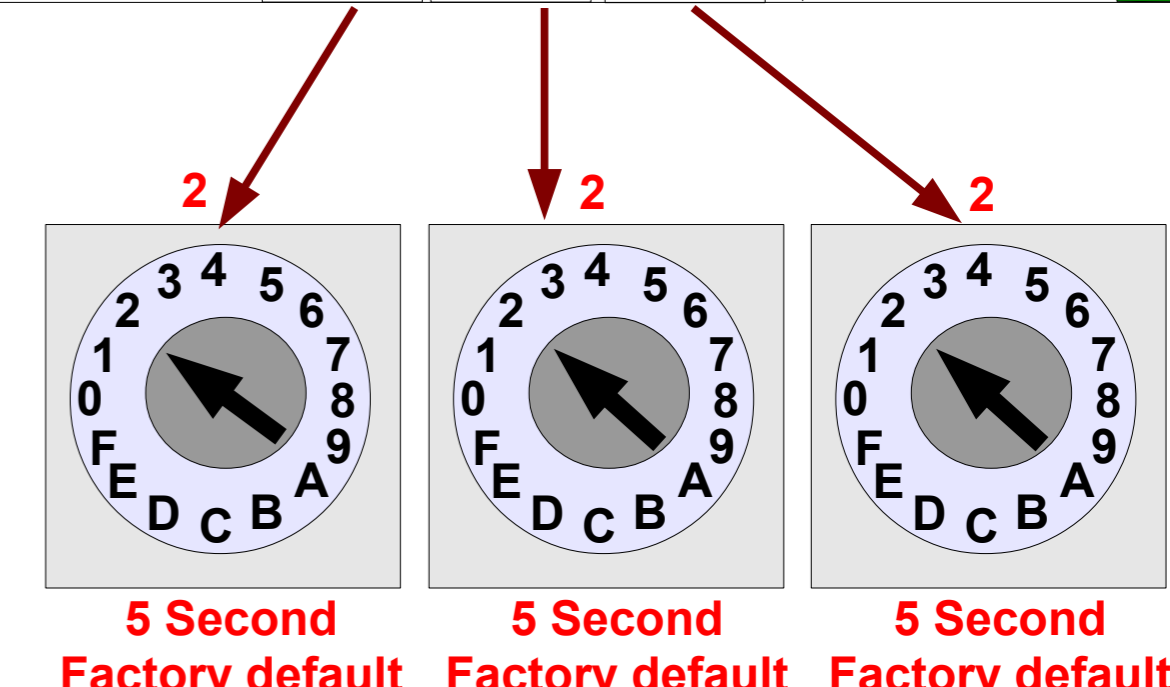
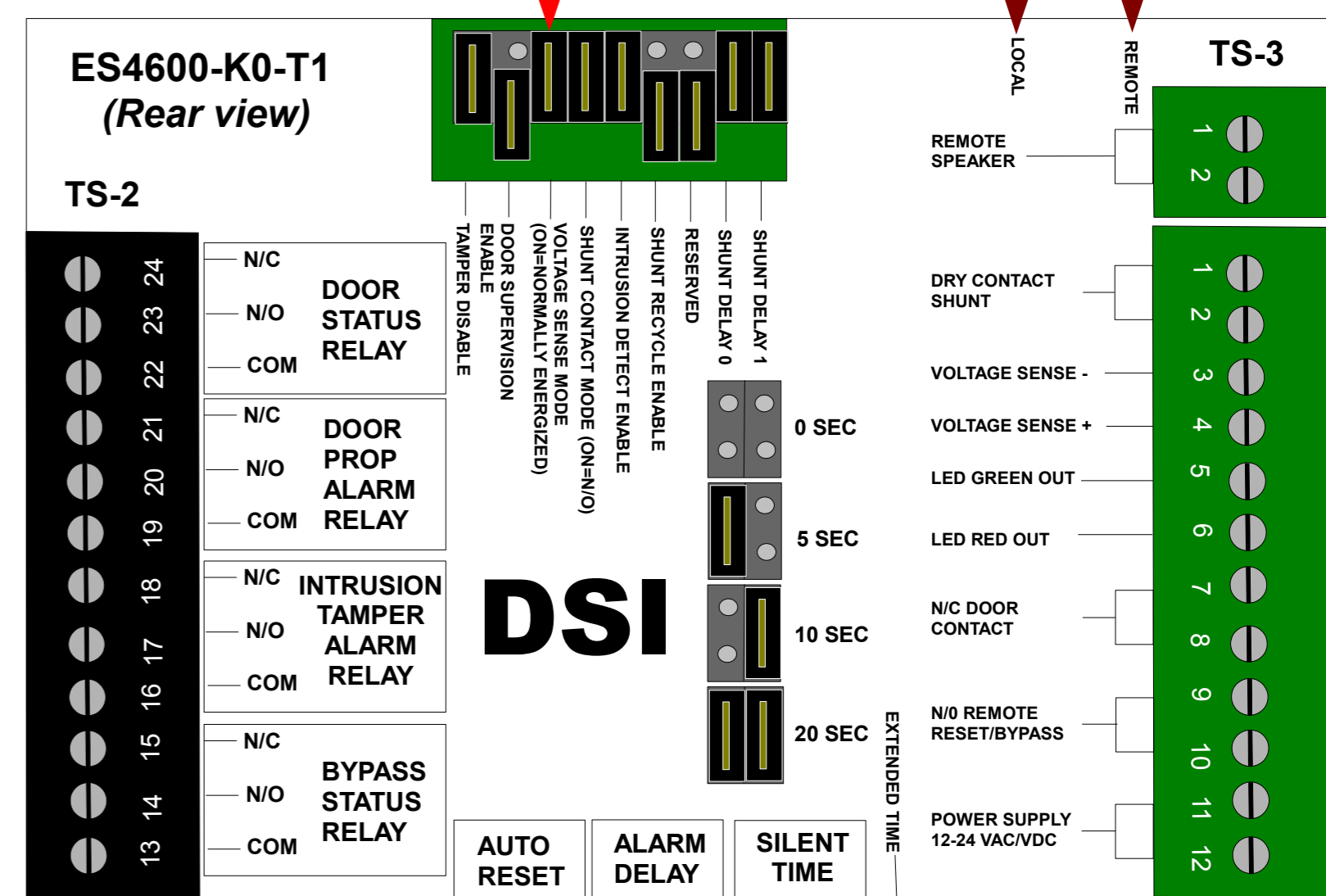

5 Second Factory default 5 Second Factory default 5 Second Factory default

SET	Auto Reset	Alarm Delay	Silent Time	
			Normal	Extended
0	0 Sec	0 Sec	0 Sec	3 Min
1	3 Sec	3 Sec	3 Sec	3.5 Min
2	5 Sec	5 Sec	5 Sec	4 Min
3	7 Sec	7 Sec	7 Sec	4.5 Min
4	10 Sec	10 Sec	10 Sec	5 Min
5	12 Sec	12 Sec	12 Sec	6 Min
6	15 Sec	15 Sec	15 Sec	7 Min
7	20 Sec	20 Sec	20 Sec	8 Min
8	30 Sec	30 Sec	25 Sec	9 Min
9	45 Sec	45 Sec	30 Sec	10 Min
A	1 Min	1 Min	35 Sec	20 Min
B	2 Min	2 Min	45 Sec	30 Min
C	3 Min	3 Min	1 Min	40 Min
D	4 Min	4 Min	1.5 Min	50 Min
E	5 Min	5 Min	2 Min	60 Min
F	Manual	Infinite	2.5 Min	90 Min

12-24 VAC/VDC
500mA
Power Supply
Sold Separately

Note:
Wire Gauge:
22 AWG = Signal wires
22 AWG = Power wires
(Power runs over 50 feet use 18 AWG)

Note:
Suggested Power Supply
PS/DC12
PS/AC16

ES4600-K0-T1 Door Strike Configuration

Push Button REX

Specifications: ES4600

Power: 12-24 VAC/VDC at 500mA

Output Relays: N/C & N/O contact 1000mA at 30 VDC

Remote Speaker: 3 Watts 8 Ohms

Warning message: "Please close the door"

Alarm message: "Security violation, close the door"

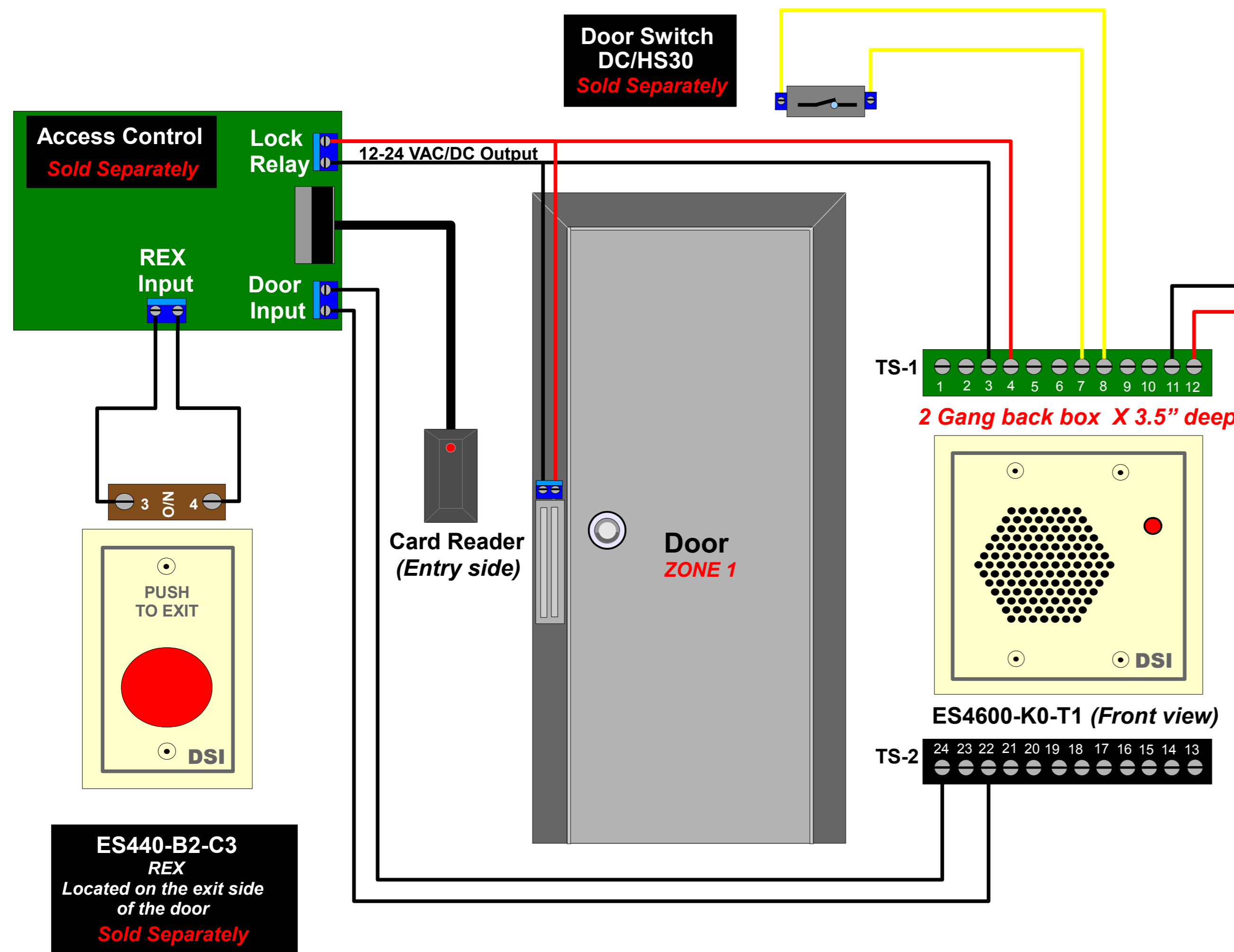

Voltage Sense Mode Jumper placement

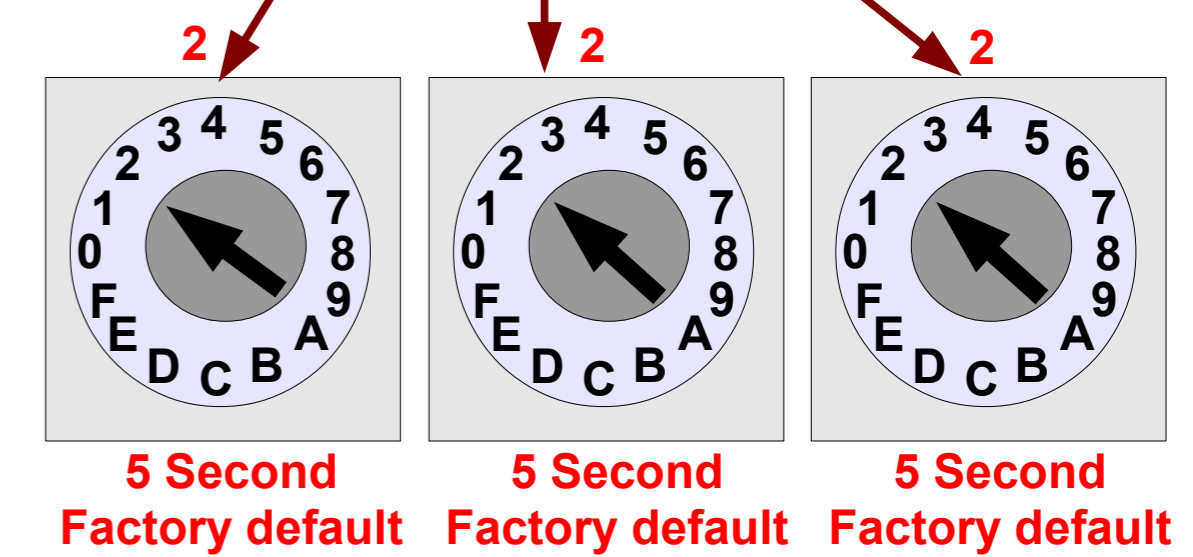
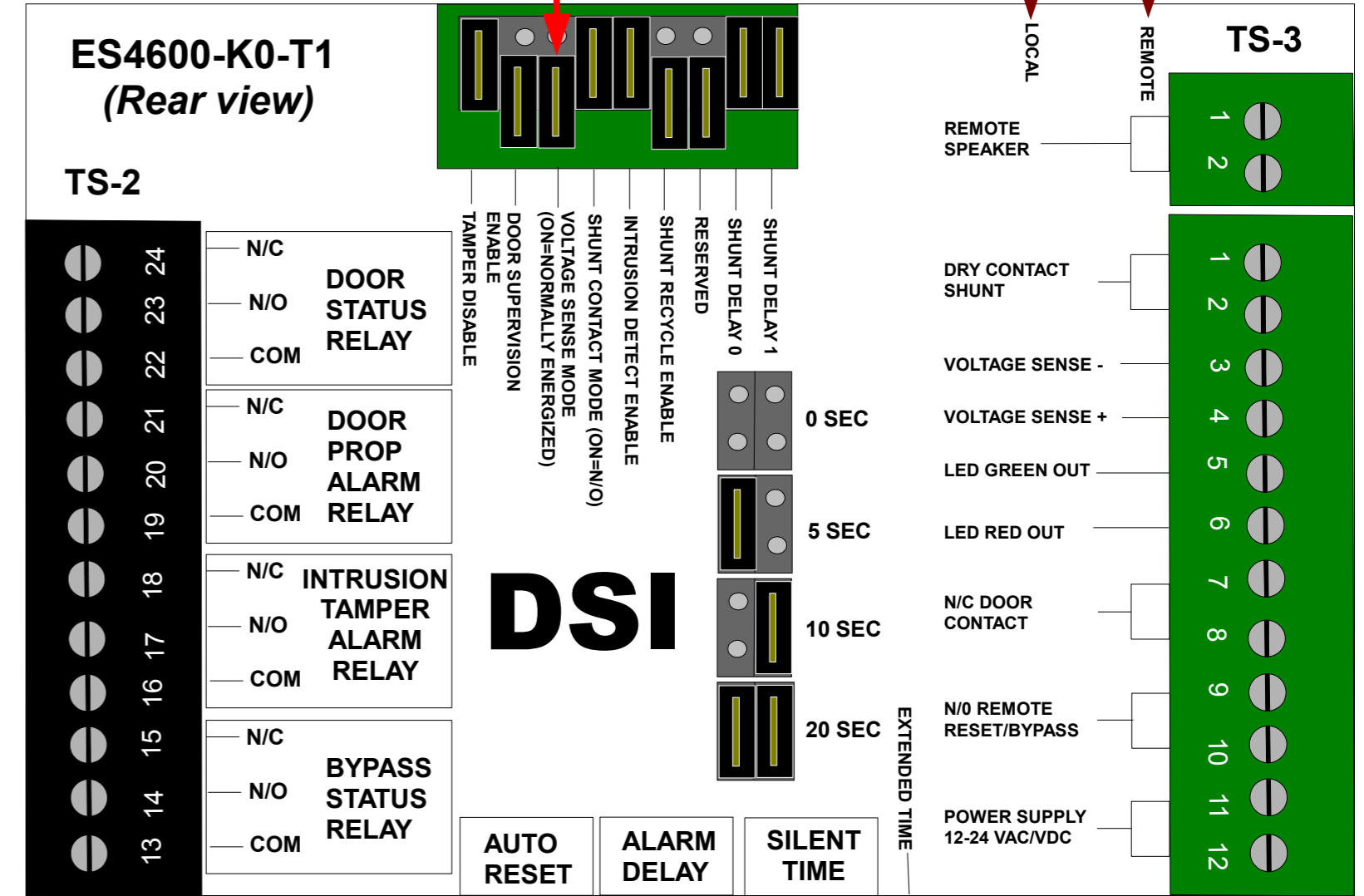

SET	Auto Reset	Alarm Delay	Silent Time	
			Normal	Extended
0	0 Sec	0 Sec	0 Sec	3 Min
1	3 Sec	3 Sec	3 Sec	3.5 Min
2	5 Sec	5 Sec	5 Sec	4 Min
3	7 Sec	7 Sec	7 Sec	4.5 Min
4	10 Sec	10 Sec	10 Sec	5 Min
5	12 Sec	12 Sec	12 Sec	6 Min
6	15 Sec	15 Sec	15 Sec	7 Min
7	20 Sec	20 Sec	20 Sec	8 Min
8	30 Sec	30 Sec	25 Sec	9 Min
9	45 Sec	45 Sec	30 Sec	10 Min
A	1 Min	1 Min	35 Sec	20 Min
B	2 Min	2 Min	45 Sec	30 Min
C	3 Min	3 Min	1 Min	40 Min
D	4 Min	4 Min	1.5 Min	50 Min
E	5 Min	5 Min	2 Min	60 Min
F	Manual	Infinite	2.5 Min	90 Min

12-24 VAC/VDC
500mA
Power Supply
Sold Separately

Note:

Wire Gauge:
22 AWG = Signal wires
22 AWG = Power wires
(Power runs over 50 feet use 18 AWG)

Note:

Suggested Power Supply
PS/DC12
PS/AC16