

ES4200-K4-T1 Exit Alarm Configuration

Specifications: ES4200
Power: 12-24 VAC/VDC at (250ma)
Output Relays: N/C & N/O contact 1000ma at 30 VDC
Horn Volume: Selectable 96db or 103 db

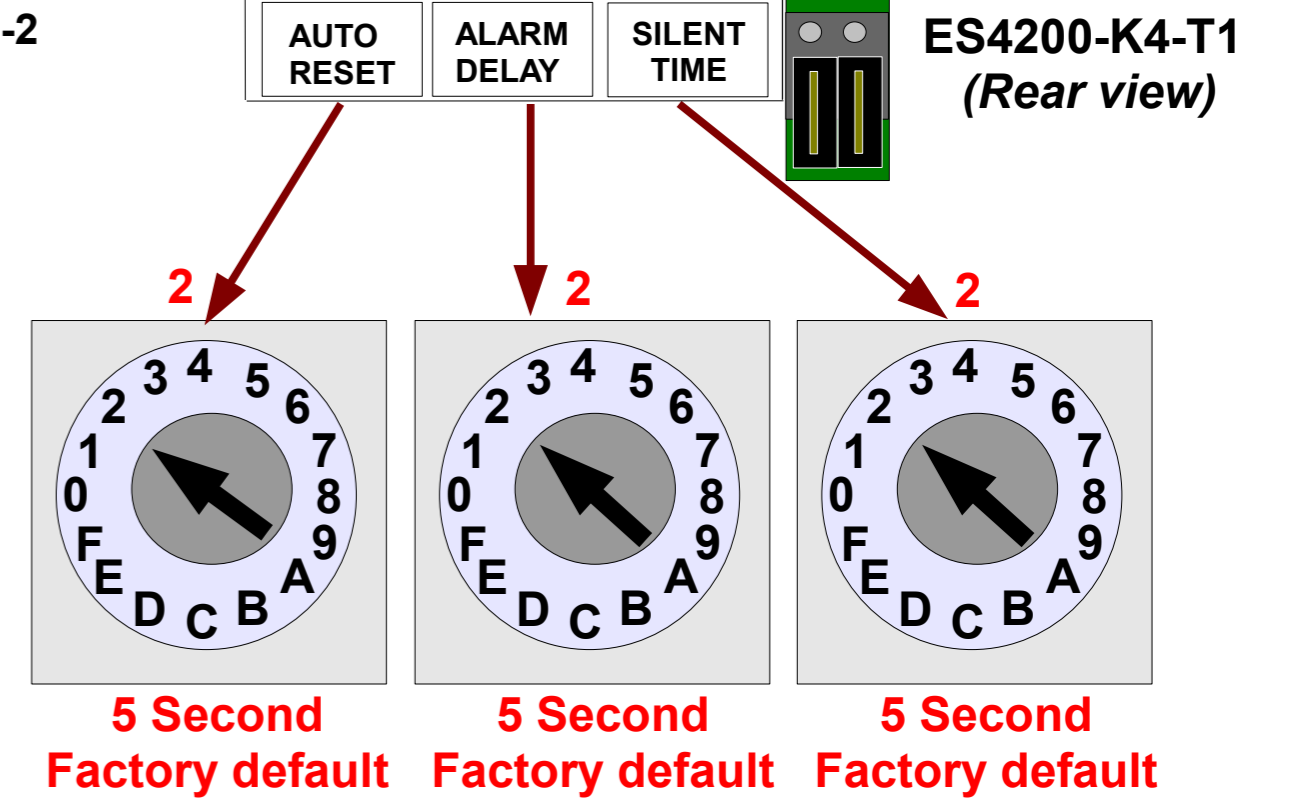
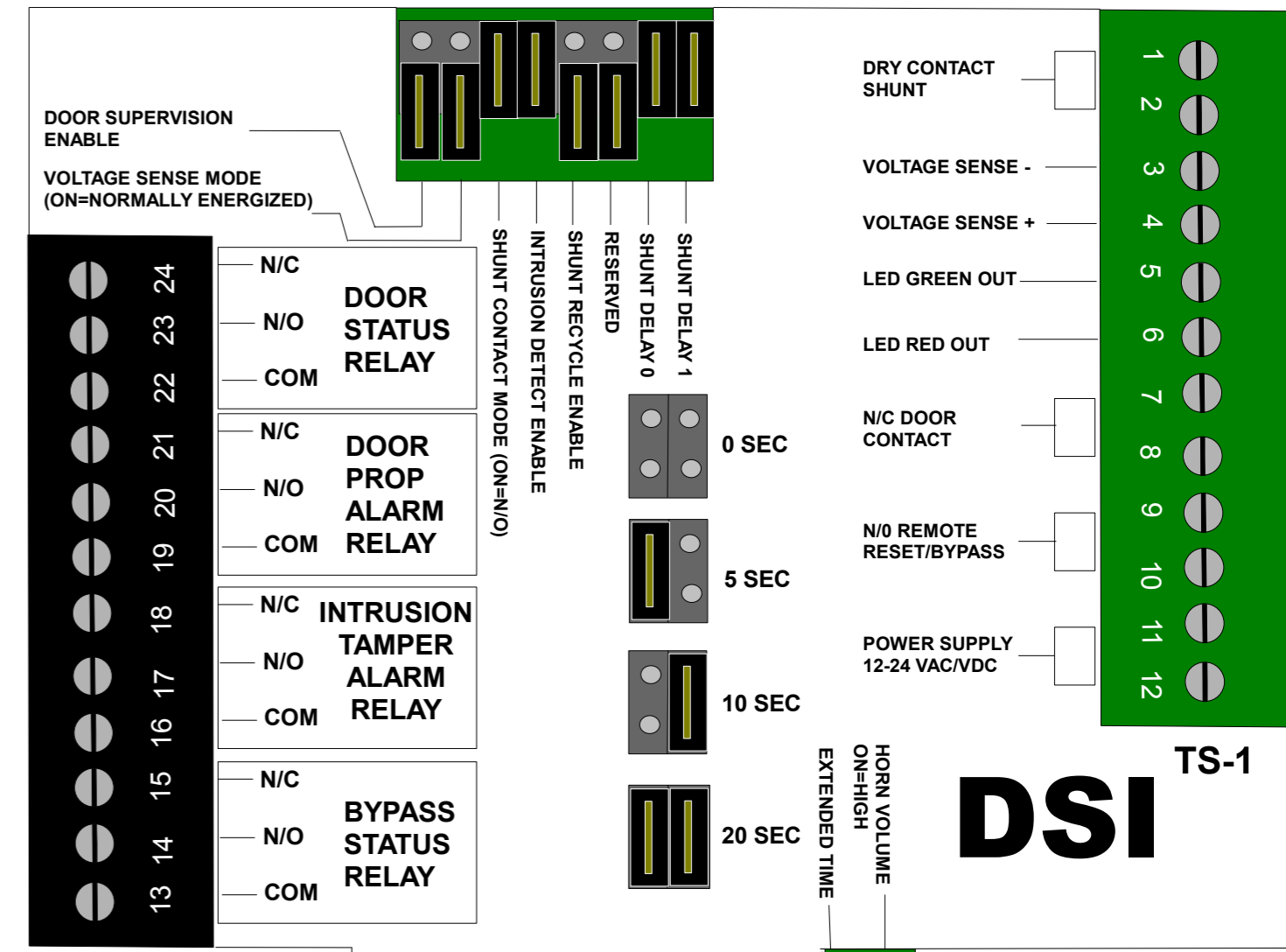
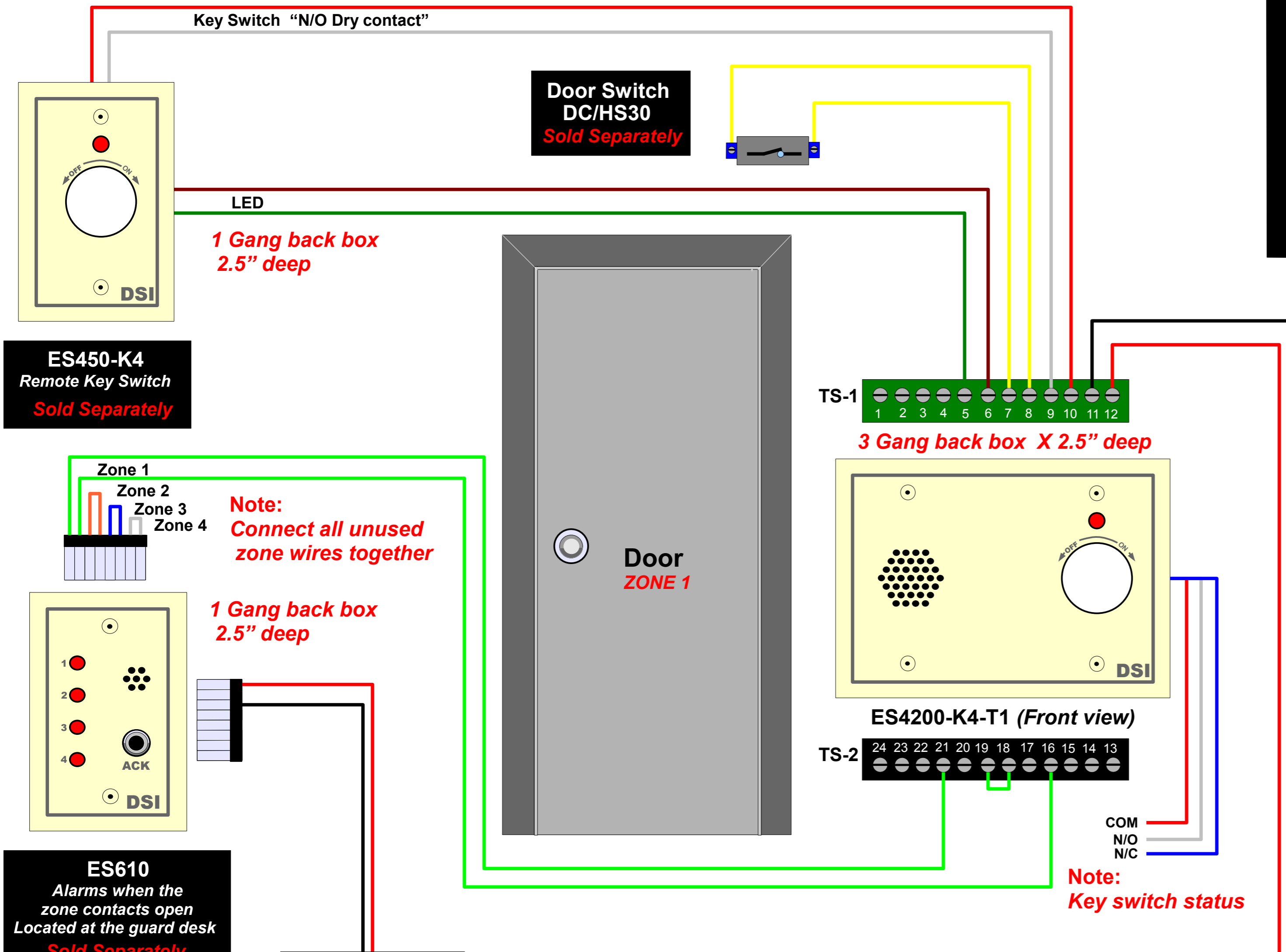

SET	Auto Reset	Alarm Delay	Silent Time	
			Normal	Extended
0	0 Sec	0 Sec	0 Sec	3 Min
1	3 Sec	3 Sec	3 Sec	3.5 Min
2	5 Sec	5 Sec	5 Sec	4 Min
3	7 Sec	7 Sec	7 Sec	4.5 Min
4	10 Sec	10 Sec	10 Sec	5 Min
5	12 Sec	12 Sec	12 Sec	6 Min
6	15 Sec	15 Sec	15 Sec	7 Min
7	20 Sec	20 Sec	20 Sec	8 Min
8	30 Sec	30 Sec	25 Sec	9 Min
9	45 Sec	45 Sec	30 Sec	10 Min
A	1 Min	1 Min	35 Sec	20 Min
B	2 Min	2 Min	45 Sec	30 Min
C	3 Min	3 Min	1 Min	40 Min
D	4 Min	4 Min	1.5 Min	50 Min
E	5 Min	5 Min	2 Min	60 Min
F	Manual	Infinite	2.5 Min	90 Min

ES450-K4
Remote Key Switch
Sold Separately

ES610
Alarms when the zone contacts open
Located at the guard desk
Sold Separately

ES610
Alarms when the zone contacts open
Located at the guard desk
Sold Separately

DSI
DESIGNED SECURITY, INC.
1-800-272-3555

12 VDC
150mA
Power Supply
Sold Separately

Note:
Wire Gauge:
22 AWG = Signal wires
22 AWG = Power wires
(Power runs over 50 feet use 18 AWG)

Note:
Suggested Power Supply
PS/DC12
PS/AC16

12-24 VAC/VDC
250mA
Power Supply
Sold Separately

Note:
Key switch status

ES4200-K4-T1 Exit Alarm Configuration

Supervised Door

Specifications: ES4200

Power: 12-24 VAC/VDC at (250ma)

Output Relays: N/C & N/O contact 1000ma at 30 VDC

Horn Volume: Selectable 96db or 103 db

Supervision Enable Jumper placement

Use 1K OHM resistors on door switch

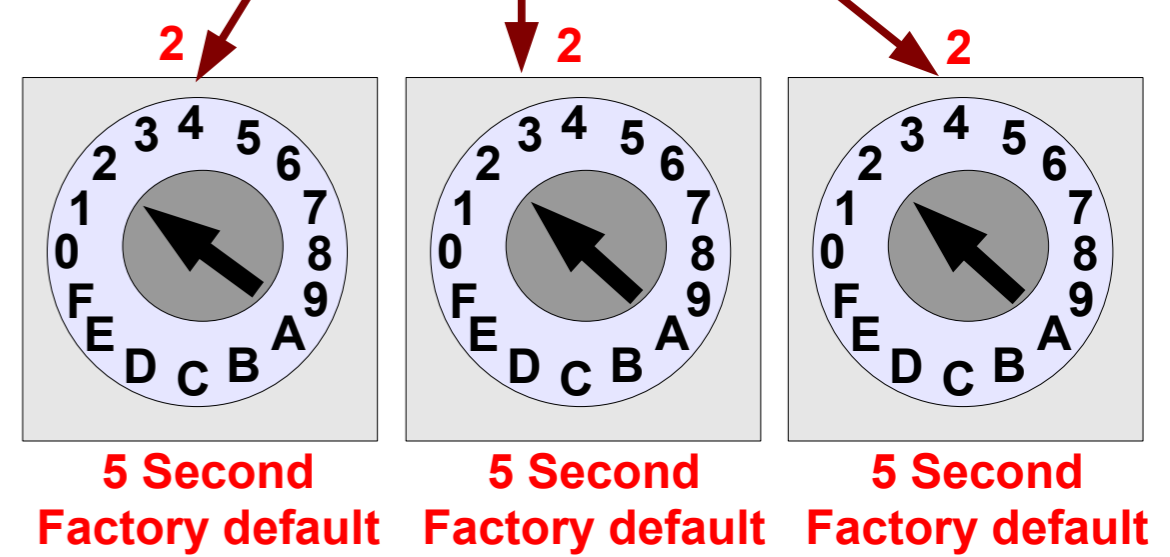
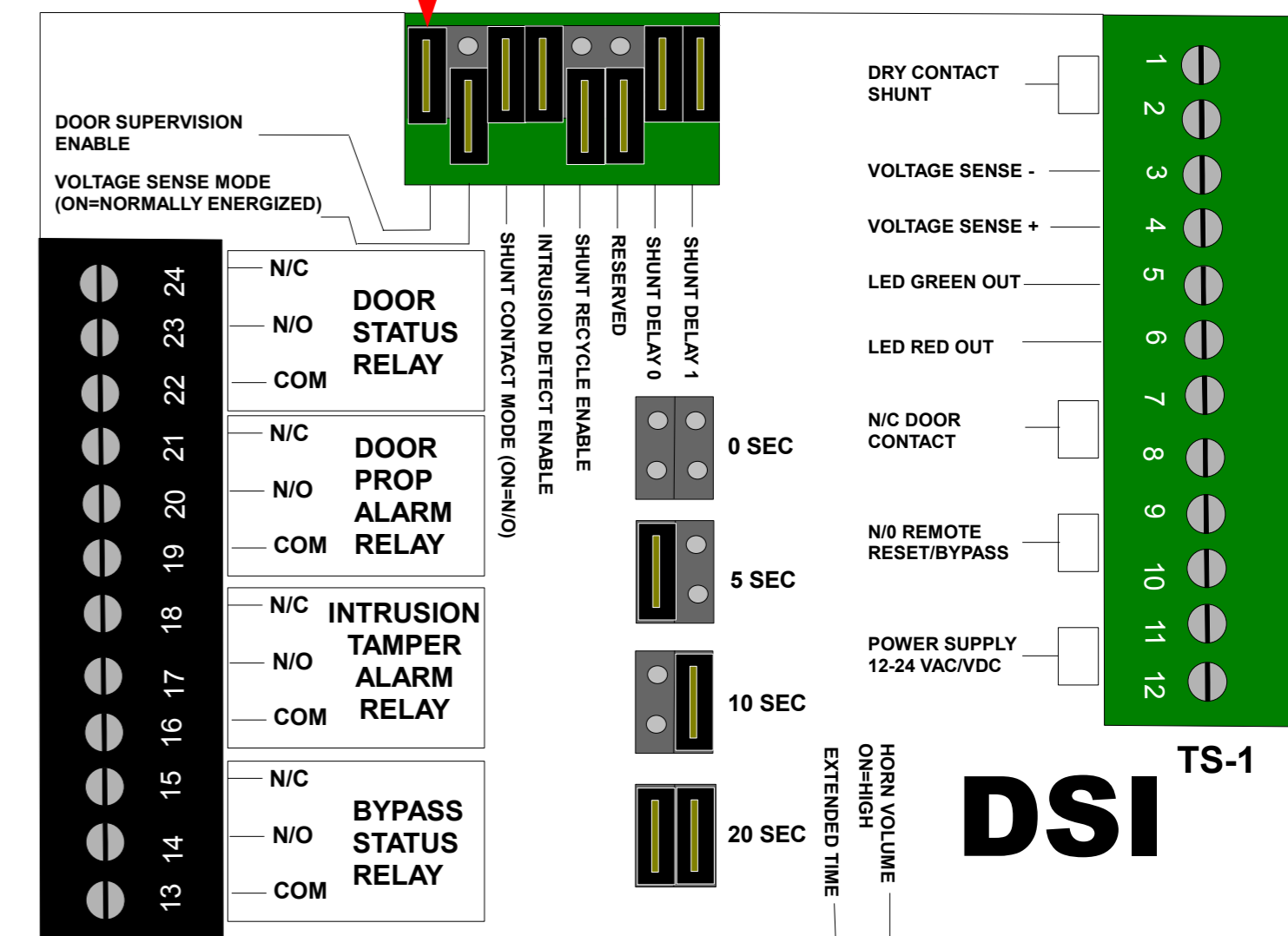
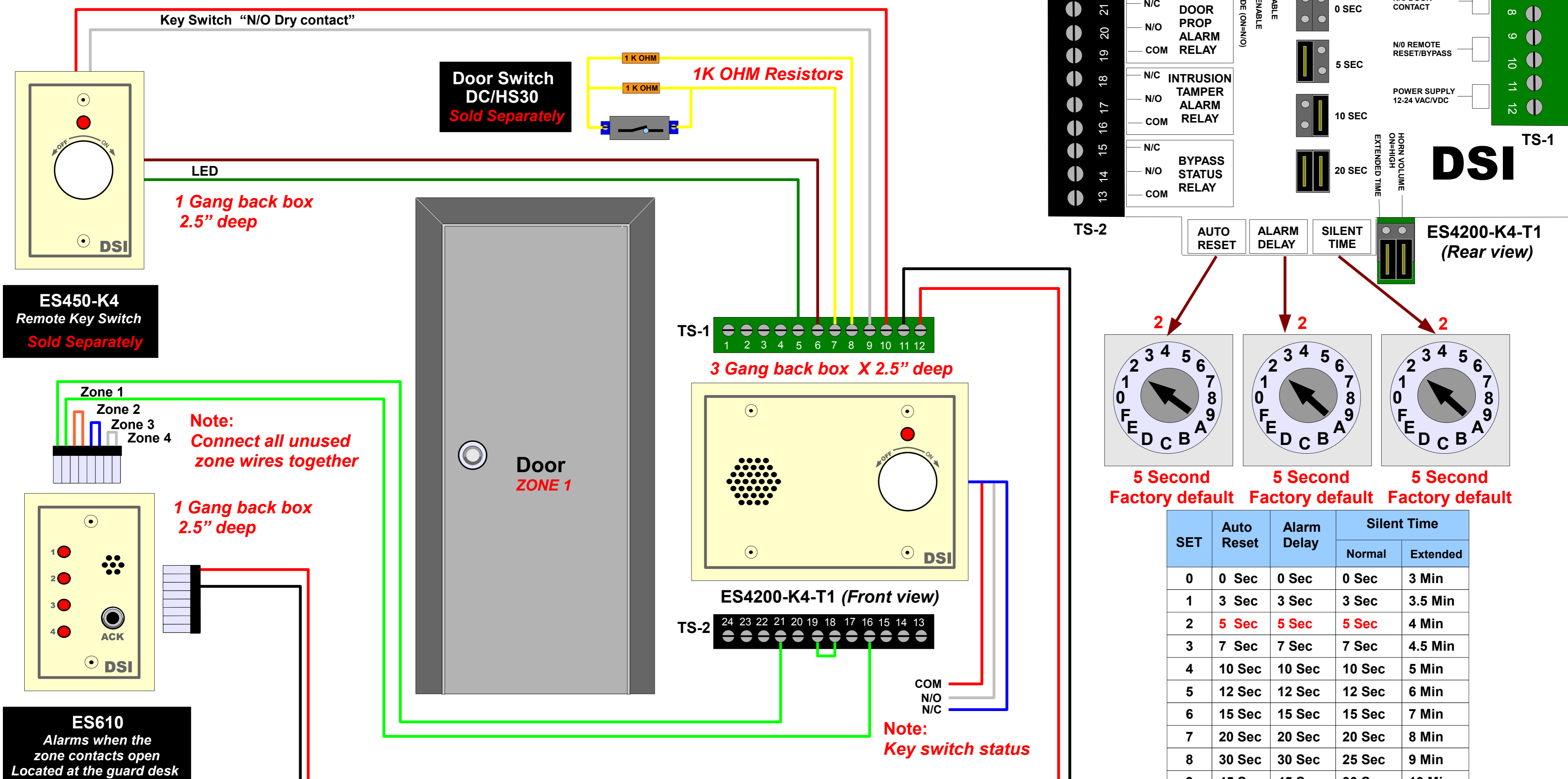

SET	Auto Reset	Alarm Delay	Silent Time	
			Normal	Extended
0	0 Sec	0 Sec	0 Sec	3 Min
1	3 Sec	3 Sec	3 Sec	3.5 Min
2	5 Sec	5 Sec	5 Sec	4 Min
3	7 Sec	7 Sec	7 Sec	4.5 Min
4	10 Sec	10 Sec	10 Sec	5 Min
5	12 Sec	12 Sec	12 Sec	6 Min
6	15 Sec	15 Sec	15 Sec	7 Min
7	20 Sec	20 Sec	20 Sec	8 Min
8	30 Sec	30 Sec	25 Sec	9 Min
9	45 Sec	45 Sec	30 Sec	10 Min
A	1 Min	1 Min	35 Sec	20 Min
B	2 Min	2 Min	45 Sec	30 Min
C	3 Min	3 Min	1 Min	40 Min
D	4 Min	4 Min	1.5 Min	50 Min
E	5 Min	5 Min	2 Min	60 Min
F	Manual	Infinite	2.5 Min	90 Min

Note: Wire Gauge:
 22 AWG = Signal wires
 22 AWG = Power wires
 (Power runs over 50 feet use 18 AWG)

Note: Suggested Power Supply
 PS/DC12
 PS/AC16

12-24 VAC/VDC 250mA Power Supply
 Sold Separately

ES4200-K4-T1 Door Prop Configuration

Specifications: ES4200
Power: 12-24 VAC/VDC at (250ma)
Output Relays: N/C & N/O contact 1000ma at 30 VDC
Horn Volume: Selectable 96db or 103 db

**Intrusion Detect Enable
 Jumper placement**

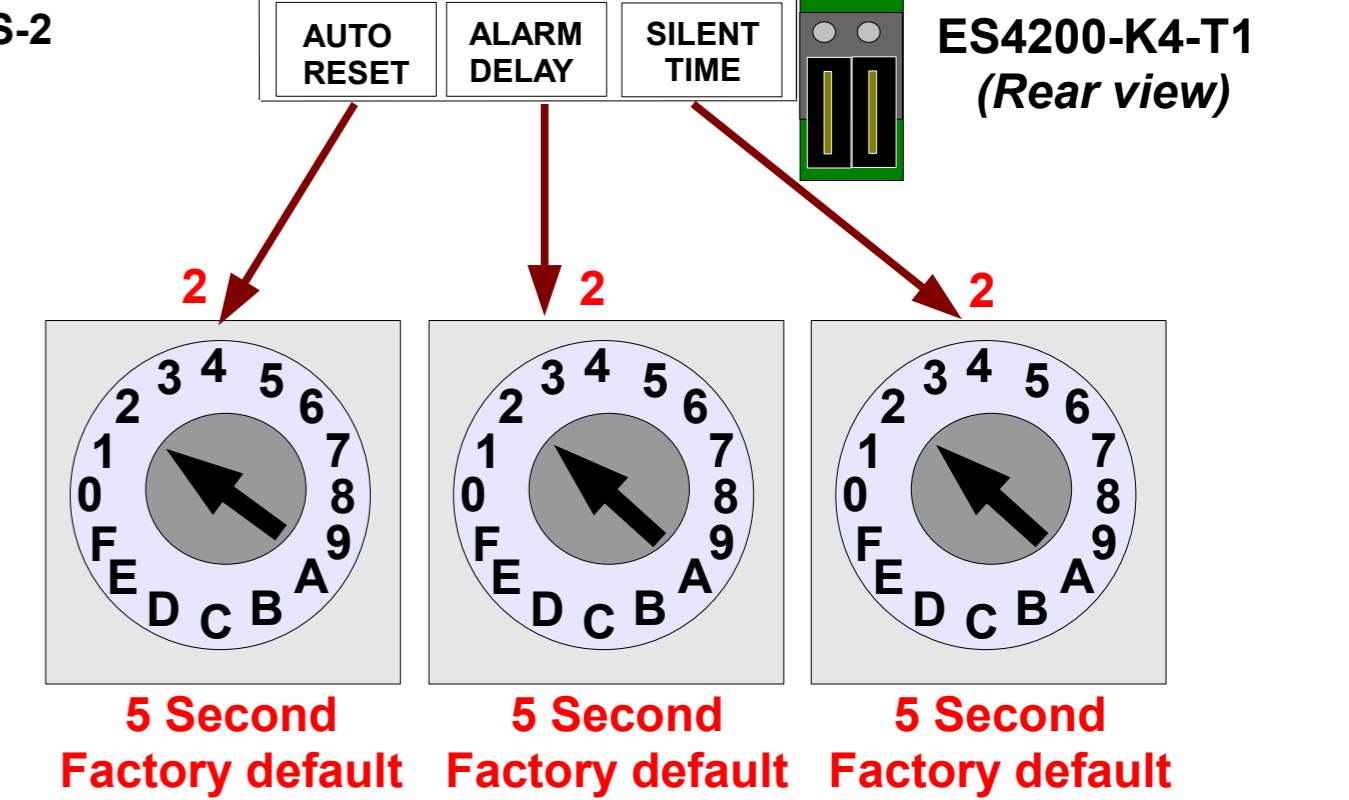
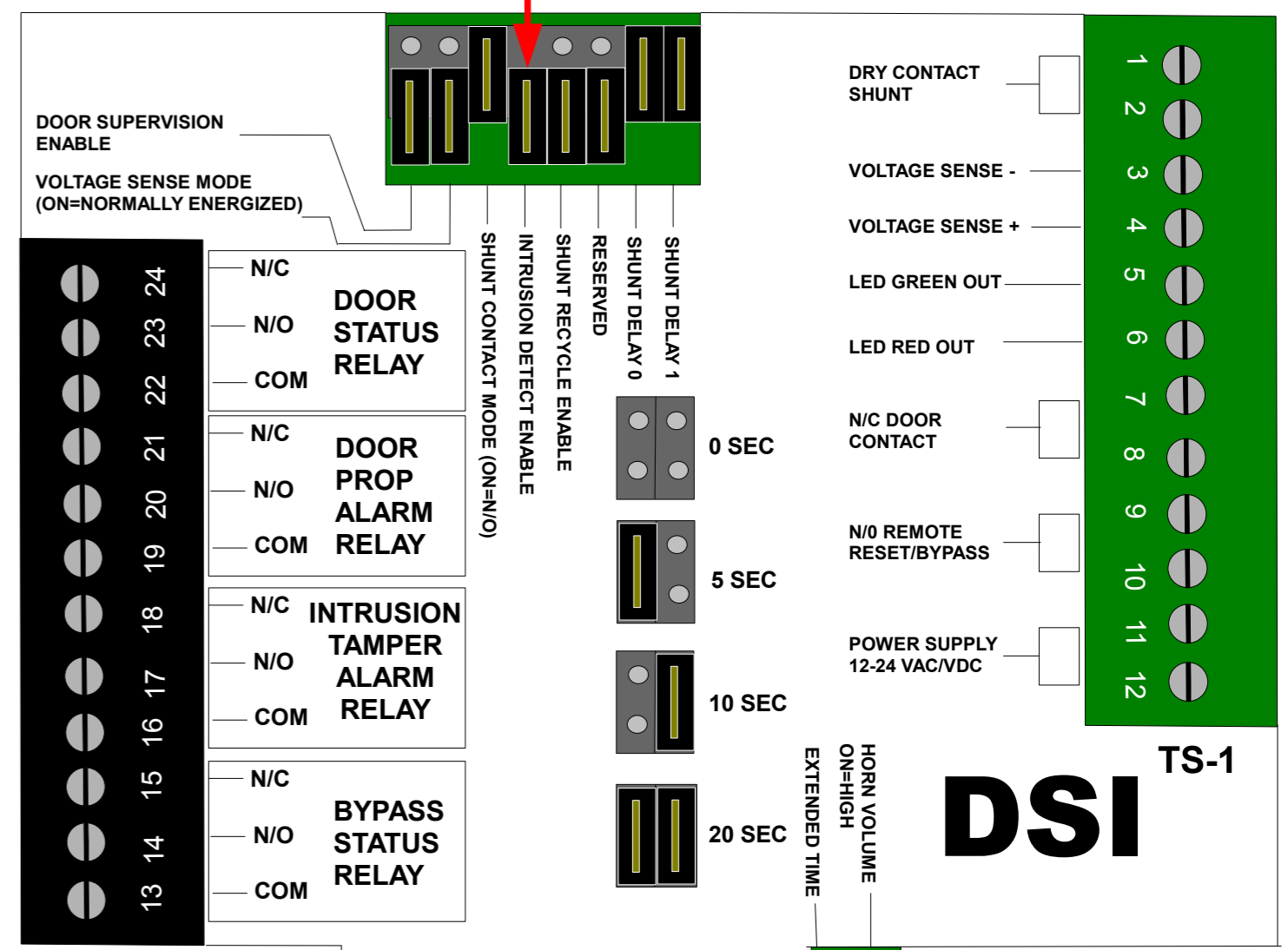
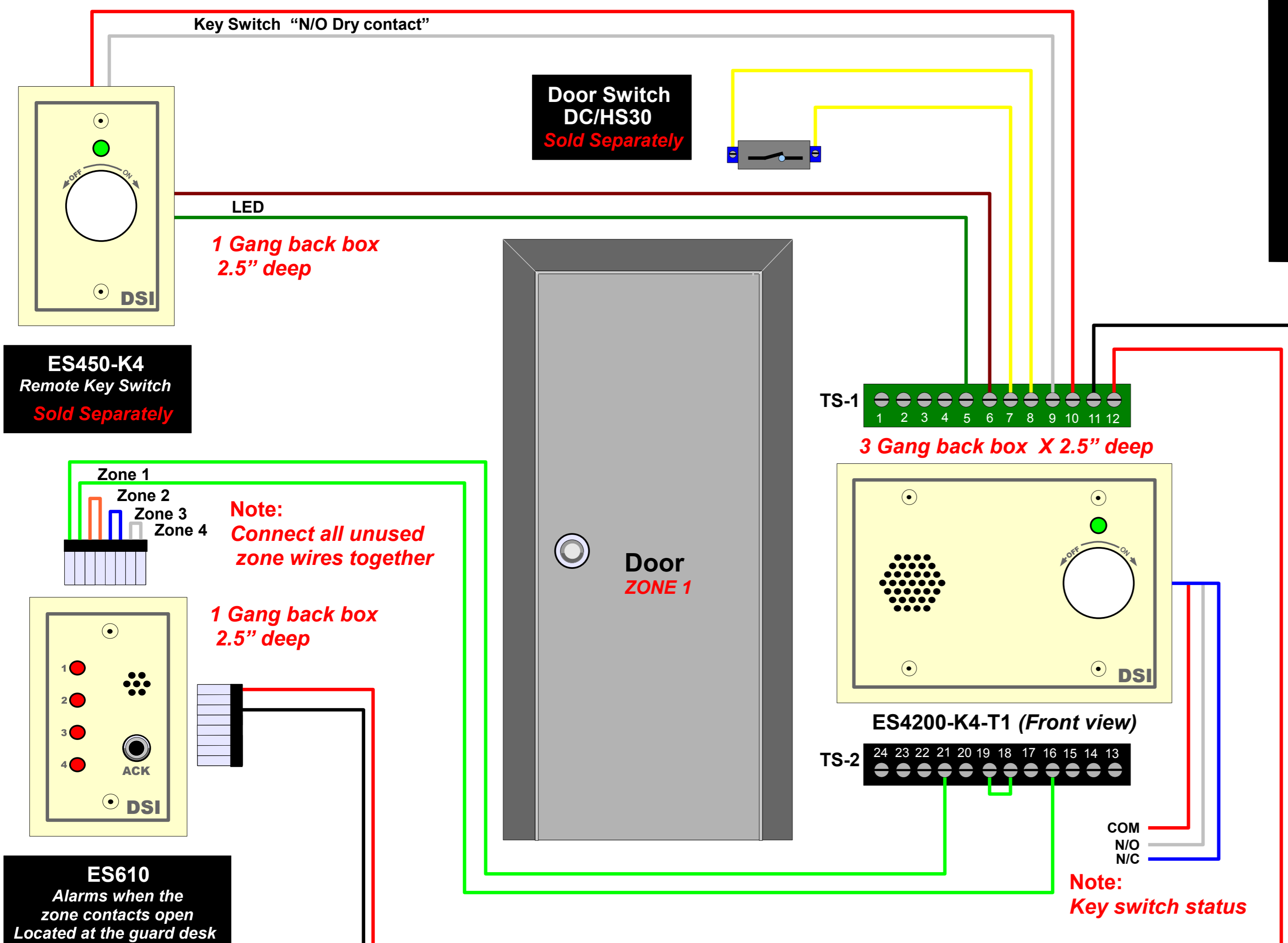

SET	Auto Reset	Alarm Delay	Silent Time	
			Normal	Extended
0	0 Sec	0 Sec	0 Sec	3 Min
1	3 Sec	3 Sec	3 Sec	3.5 Min
2	5 Sec	5 Sec	5 Sec	4 Min
3	7 Sec	7 Sec	7 Sec	4.5 Min
4	10 Sec	10 Sec	10 Sec	5 Min
5	12 Sec	12 Sec	12 Sec	6 Min
6	15 Sec	15 Sec	15 Sec	7 Min
7	20 Sec	20 Sec	20 Sec	8 Min
8	30 Sec	30 Sec	25 Sec	9 Min
9	45 Sec	45 Sec	30 Sec	10 Min
A	1 Min	1 Min	35 Sec	20 Min
B	2 Min	2 Min	45 Sec	30 Min
C	3 Min	3 Min	1 Min	40 Min
D	4 Min	4 Min	1.5 Min	50 Min
E	5 Min	5 Min	2 Min	60 Min
F	Manual	Infinite	2.5 Min	90 Min

ES450-K4
Remote Key Switch
Sold Separately

ES610
Alarms when the zone contacts open
Located at the guard desk
Sold Separately

ES610
Alarms when the zone contacts open
Located at the guard desk
Sold Separately

DSI
DESIGNED SECURITY, INC.
1-800-272-3555

12 VDC
150mA
Power Supply
Sold Separately

Note:
Wire Gauge:
22 AWG = Signal wires
22 AWG = Power wires
(Power runs over 50 feet use 18 AWG)

Note:
Suggested Power Supply
PS/DC12
PS/AC16

12-24 VAC/VDC
250mA
Power Supply
Sold Separately

Note:
Key switch status

ES4200-K4-T1 Magnetic Lock Configuration

Push Button REX

Specifications: ES4200

Power: 12-24 VAC/VDC at (250ma)

Output Relays: N/C & N/O contact 1000ma at 30 VDC

Horn Volume: Selectable 96db or 103 db

Voltage Sense Mode
Jumper placement

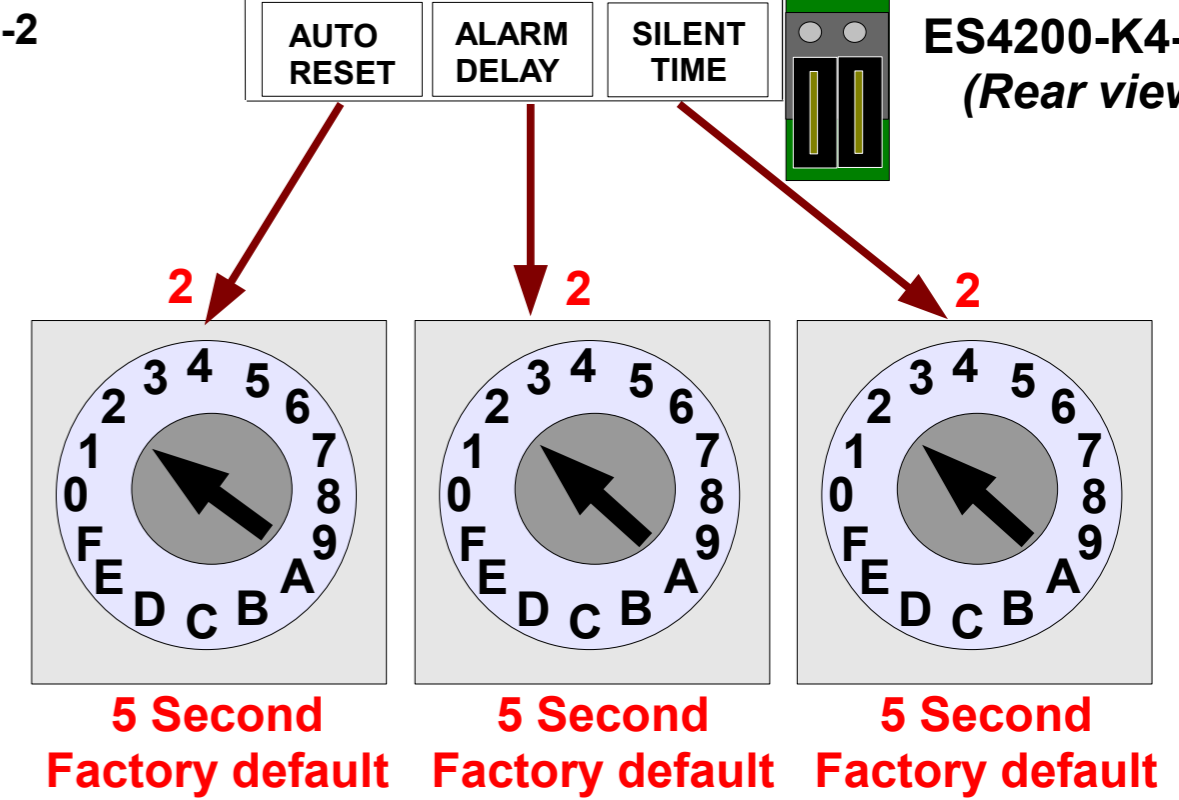
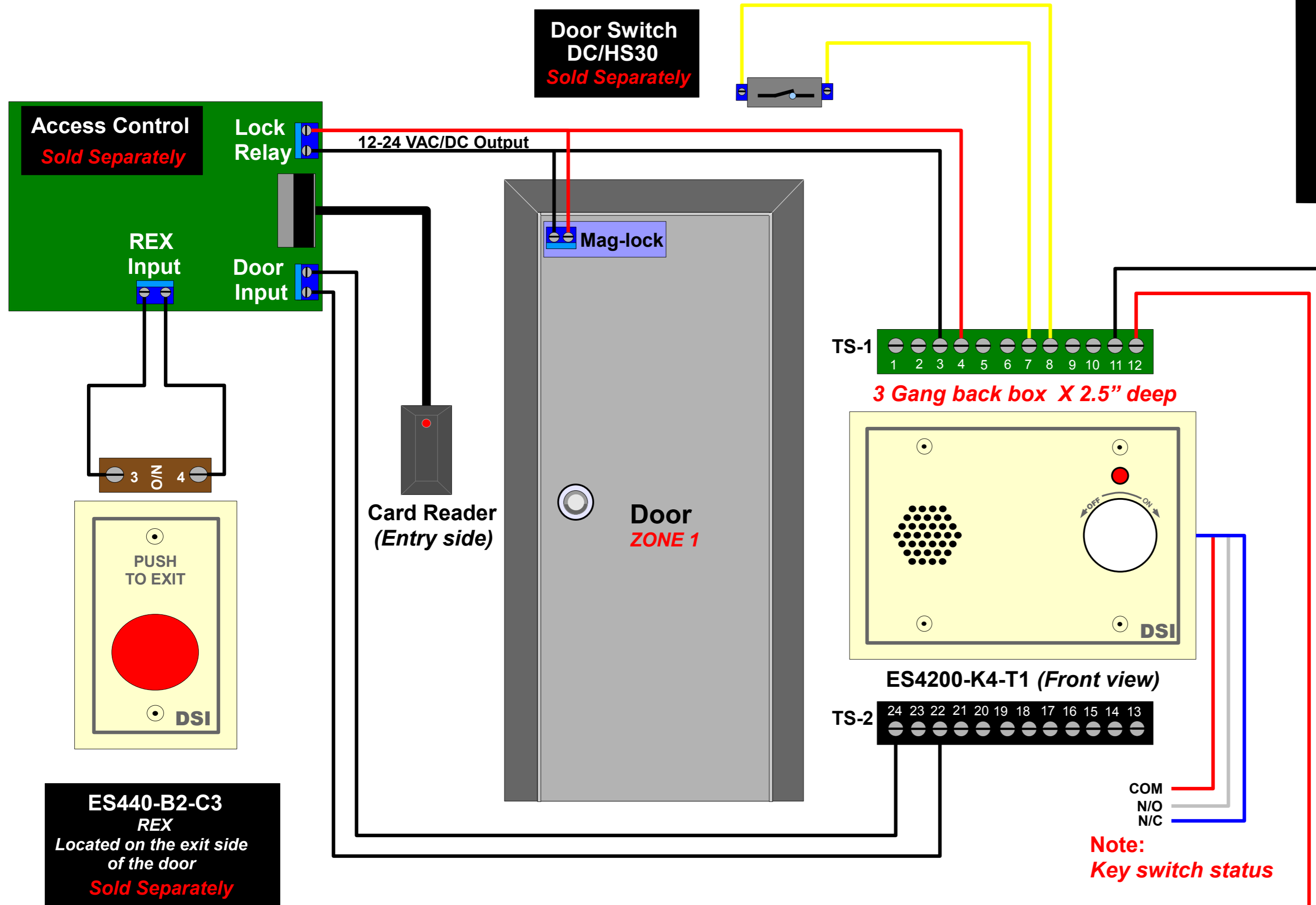
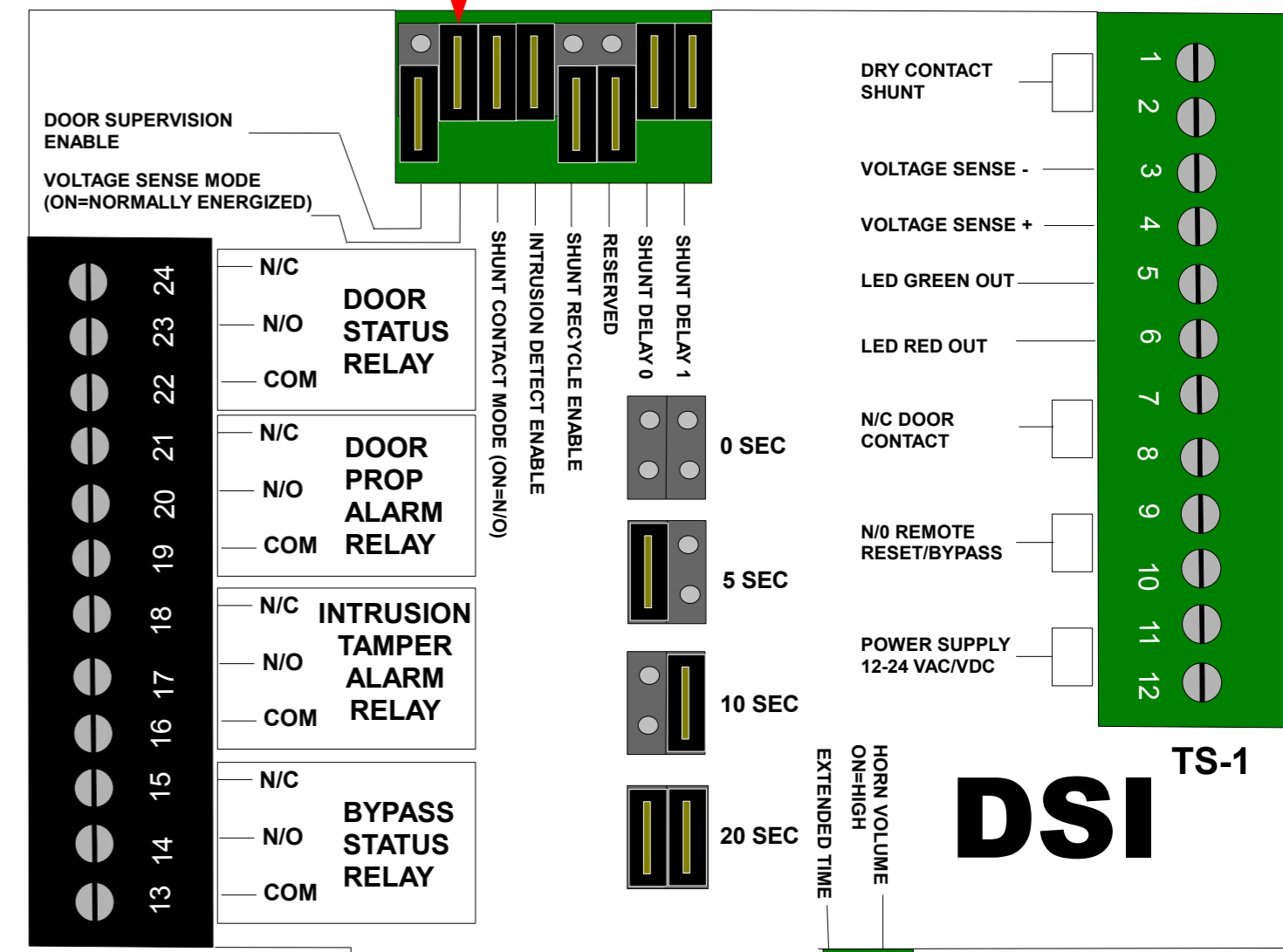

SET	Auto Reset	Alarm Delay	Silent Time	
			Normal	Extended
0	0 Sec	0 Sec	0 Sec	3 Min
1	3 Sec	3 Sec	3 Sec	3.5 Min
2	5 Sec	5 Sec	5 Sec	4 Min
3	7 Sec	7 Sec	7 Sec	4.5 Min
4	10 Sec	10 Sec	10 Sec	5 Min
5	12 Sec	12 Sec	12 Sec	6 Min
6	15 Sec	15 Sec	15 Sec	7 Min
7	20 Sec	20 Sec	20 Sec	8 Min
8	30 Sec	30 Sec	25 Sec	9 Min
9	45 Sec	45 Sec	30 Sec	10 Min
A	1 Min	1 Min	35 Sec	20 Min
B	2 Min	2 Min	45 Sec	30 Min
C	3 Min	3 Min	1 Min	40 Min
D	4 Min	4 Min	1.5 Min	50 Min
E	5 Min	5 Min	2 Min	60 Min
F	Manual	Infinite	2.5 Min	90 Min

Note: Wire Gauge:
22 AWG = Signal wires
22 AWG = Power wires
(Power runs over 50 feet use 18 AWG)

Note: Suggested Power Supply
PS/DC12
PS/AC16

12-24 VAC/VDC
250mA
Power Supply
Sold Separately

ES4200-K4-T1 Door Strike Configuration

Push Button REX

Specifications: ES4200

Power: 12-24 VAC/VDC at (250ma)

Output Relays: N/C & N/O contact 1000ma at 30 VDC

Horn Volume: Selectable 96db or 103 db

Voltage Sense Mode
Jumper placement

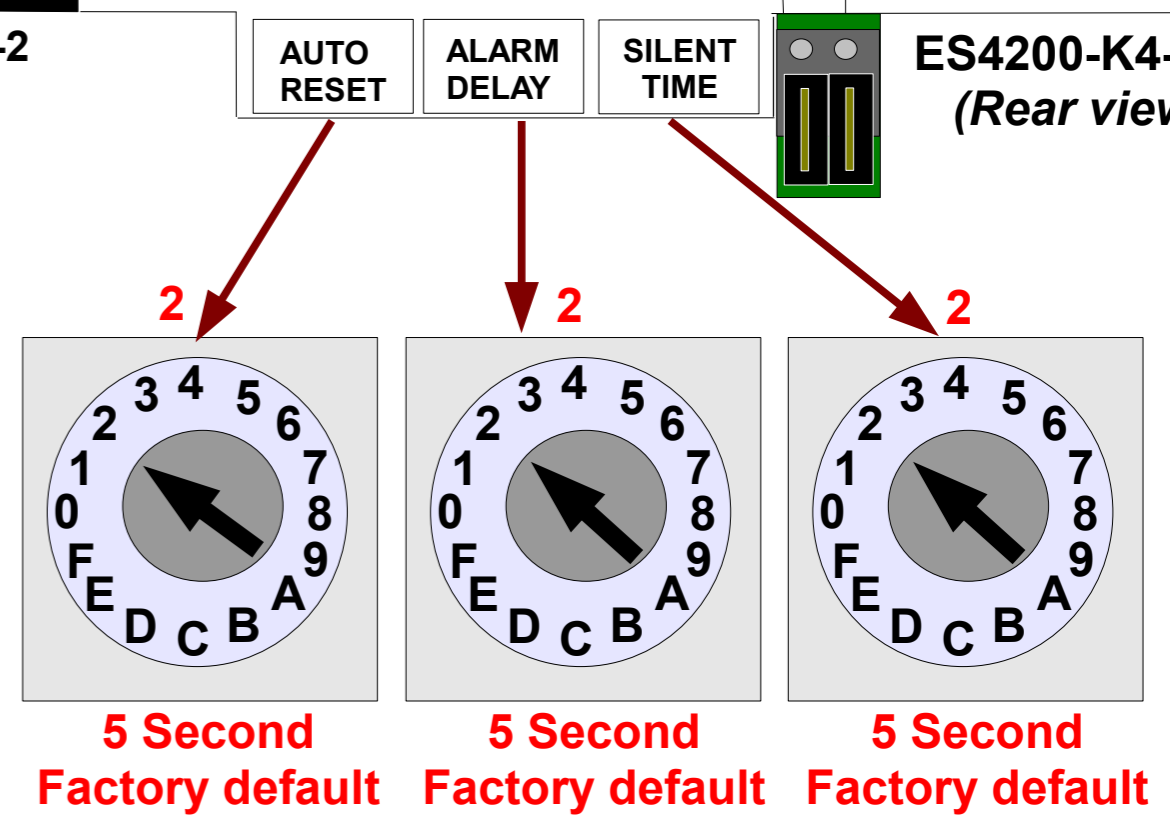
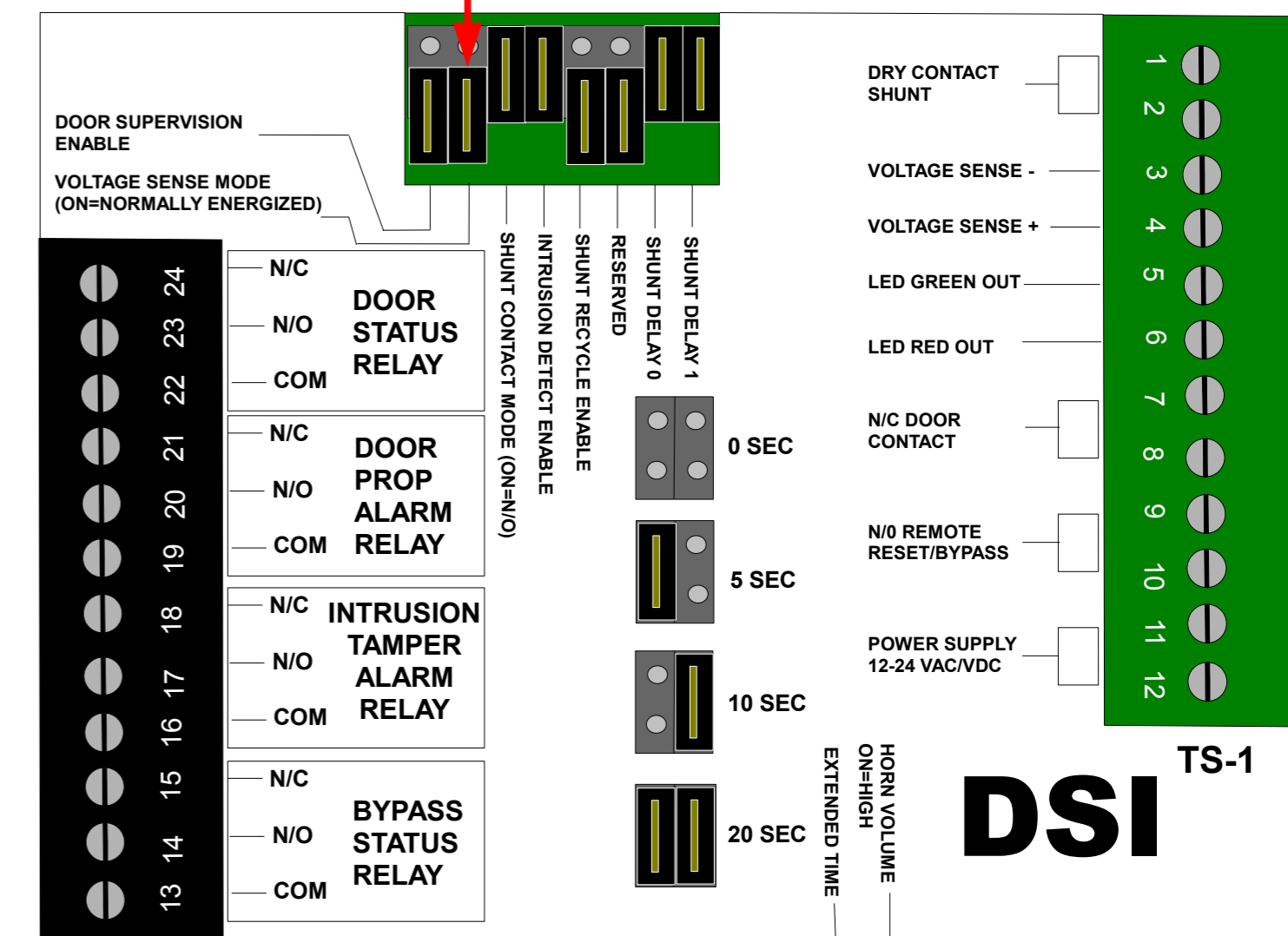
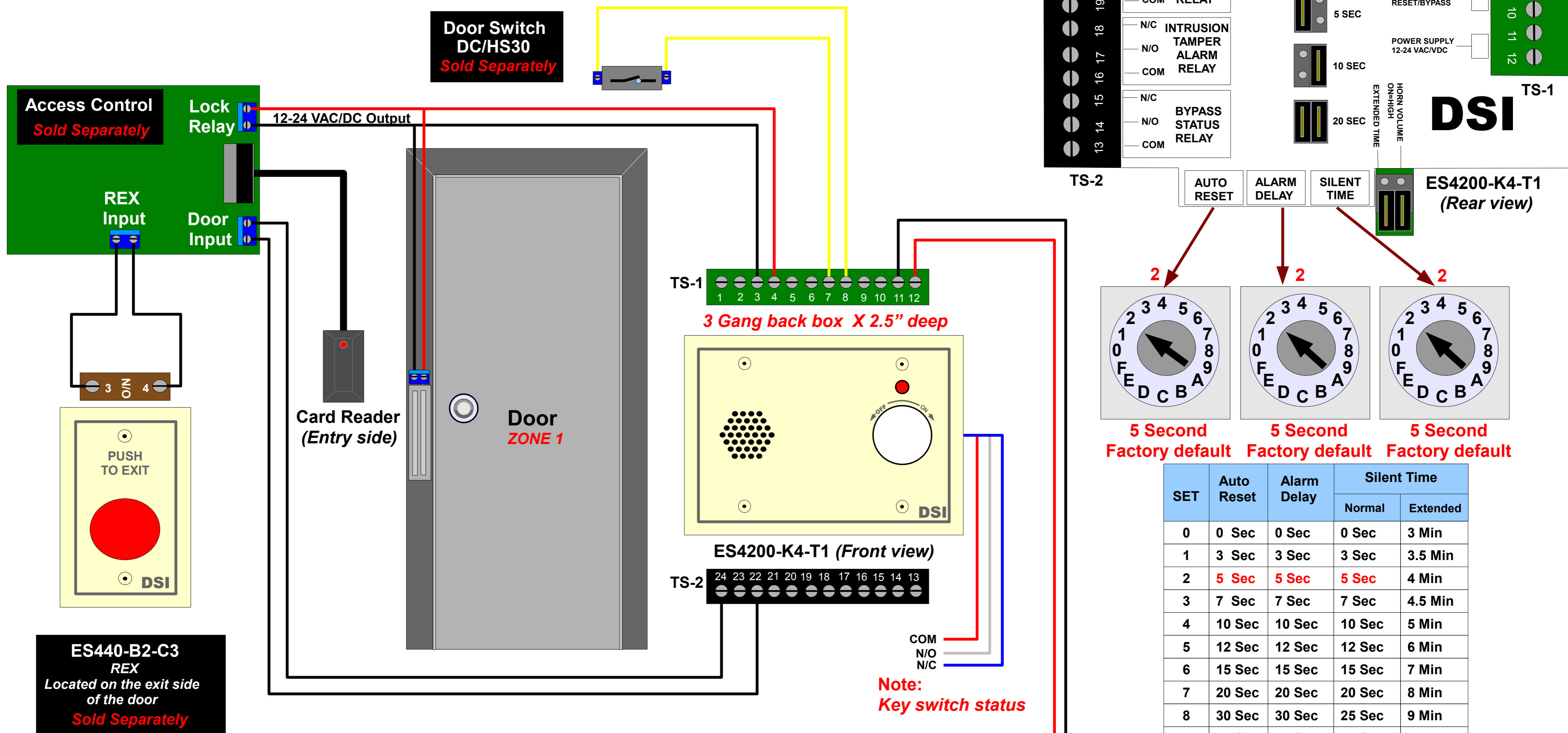

SET	Auto Reset	Alarm Delay	Silent Time	
			Normal	Extended
0	0 Sec	0 Sec	0 Sec	3 Min
1	3 Sec	3 Sec	3 Sec	3.5 Min
2	5 Sec	5 Sec	5 Sec	4 Min
3	7 Sec	7 Sec	7 Sec	4.5 Min
4	10 Sec	10 Sec	10 Sec	5 Min
5	12 Sec	12 Sec	12 Sec	6 Min
6	15 Sec	15 Sec	15 Sec	7 Min
7	20 Sec	20 Sec	20 Sec	8 Min
8	30 Sec	30 Sec	25 Sec	9 Min
9	45 Sec	45 Sec	30 Sec	10 Min
A	1 Min	1 Min	35 Sec	20 Min
B	2 Min	2 Min	45 Sec	30 Min
C	3 Min	3 Min	1 Min	40 Min
D	4 Min	4 Min	1.5 Min	50 Min
E	5 Min	5 Min	2 Min	60 Min
F	Manual	Infinite	2.5 Min	90 Min

Note: Wire Gauge:
22 AWG = Signal wires
22 AWG = Power wires
(Power runs over 50 feet use 18 AWG)

Note: Suggested Power Supply
PS/DC12
PS/AC16

12-24 VAC/VDC
250mA
Power Supply
Sold Separately